

SCHROFF MTCA.4 & ATCA PRODUCTS

MAY 29, 2014

KEK, JAPAN

Dietmar Mann / Ralf Waldt

Pentair / Schroff GmbH

dietmar.mann@pentair.com / ralf.waldt@pentair.com

OVERVIEW

Crates:

- MTCA.4 crate with 7 AMC slots for laboratory and deployment use
- MTCA.4 Deployment crate for 12 AMC slots, front to rear cooling
- MTCA.4 Deployment crate for 12 AMC slots, bottom to top cooling
- MTCA.4 Deployment crate 2U 6-Slot
- MTCA.0 Small form factor modular crate for one or two AMC modules
- ATCA 6-Slot AC-DC
- ATCA 14-Slot AC

Accessories

- MTCA.4 Filler / Blocker Modules
- Front panels and handles

Simulation and testing

Schroff MTCA.4 Products

MTCA.4 crate with 7 AMC slots for laboratory and deployment use

- **Front:**
 - 6 x AMC slots double-wide, mid-size
 - 1 x AMC slots double-wide, full-size
 - 1 x PM (Power Module) Slot
 - 1 x MCH slot
- **Rear:**
 - 6 x RTM slots double-wide, mid-size
 - 1 x RTM slots double-wide, mid-size
- **Hot Swappable CU (Cooling Unit) including removable air filter**
- **Application: development system in various laboratories including DESY , SLAC and CERN**
- **Order information: Schroff P/N 11850-021**



Schroff MTCA.4 Products

MTCA.4 crate with 7 AMC slots for laboratory and deployment use

Backplane topology

- Common Options: 2 x GbE to all AMC slots
 - Direct SATA links between AMC slots
 - PCIe x4 between MCH and AMC slots
-
- Point-to-Point links
 - Bussed links for Clock and Trigger signals
-
- TCLKA
 - TCLKB
 - PCIe clock

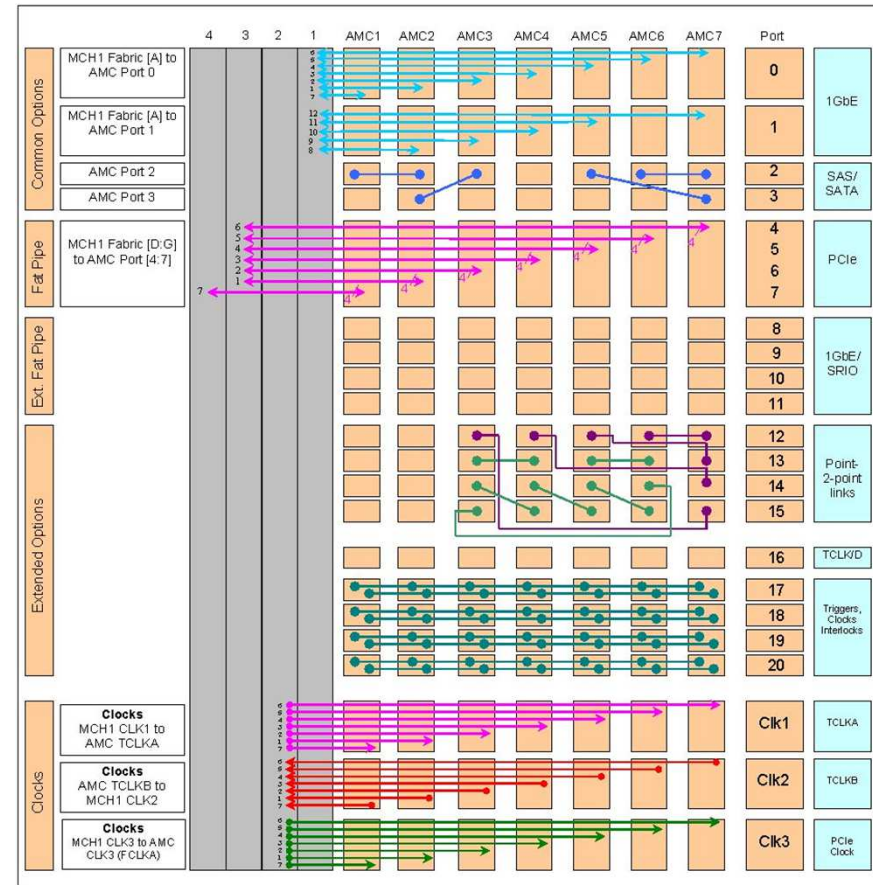

Schroff MTCA.4 Products

MTCA.4 crate with 7 AMC slots for laboratory and deployment use

- Side-by-side mounting kit for 19"-Rack installation

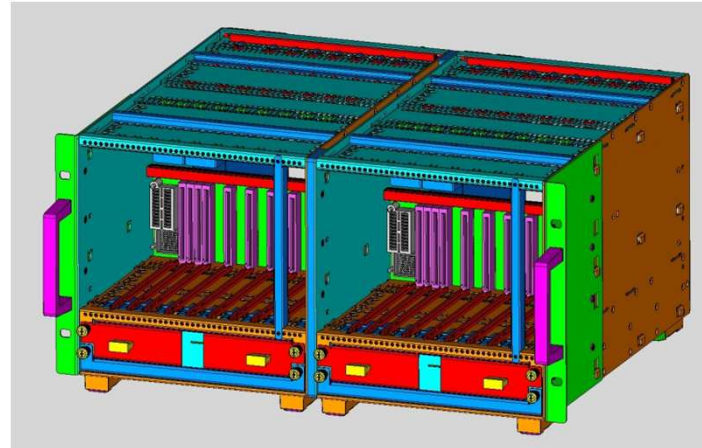

- Air flow: bottom intake, top exhaust

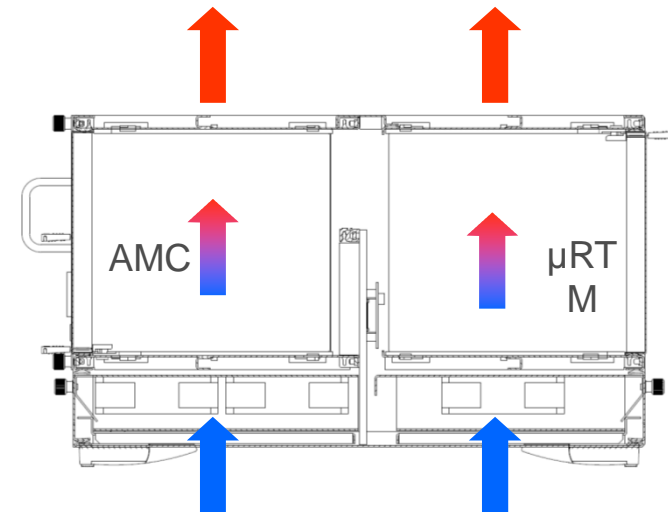

Schroff MTCA.4 Products

Deployment crate for 12 AMC slots

- **Front Module Slots:**
 - 12 x AMC slots double-wide, mid-size
 - 4 x PM (Power Module) Slot
 - 2 x MCH slot
- **Rear Module Slots:**
 - 12 x RTM slots double-wide, mid-size
- **19" wide x Height 9U**
- **Push-Pull cooling with front removable fan trays**
- **Front removable Air filter**
- **Air flow front bottom air intake, to rear air exhaust**
- **Order information: Schroff P/N 11850-026**

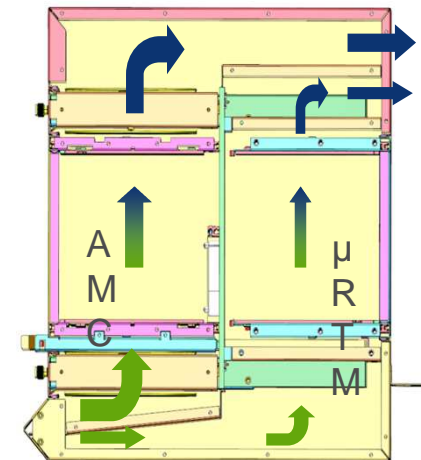

Schroff MTCA.4 Products

Deployment crate for 12 AMC slots, Backplane topology

- Common Options: 2 x GbE to all AMC slots
- Direct SATA links between AMC slots
- PCIe x4 between MCH and AMC slots
- Point-to-Point links
- Bussed links for Clock and Trigger signals
- TCLKA from MCH 1
- TCLKB from MCH 1
- TCLKC from MCH 2
- TCLKD from MCH 2
- FCLKA from MCH 1
- PCIe clock

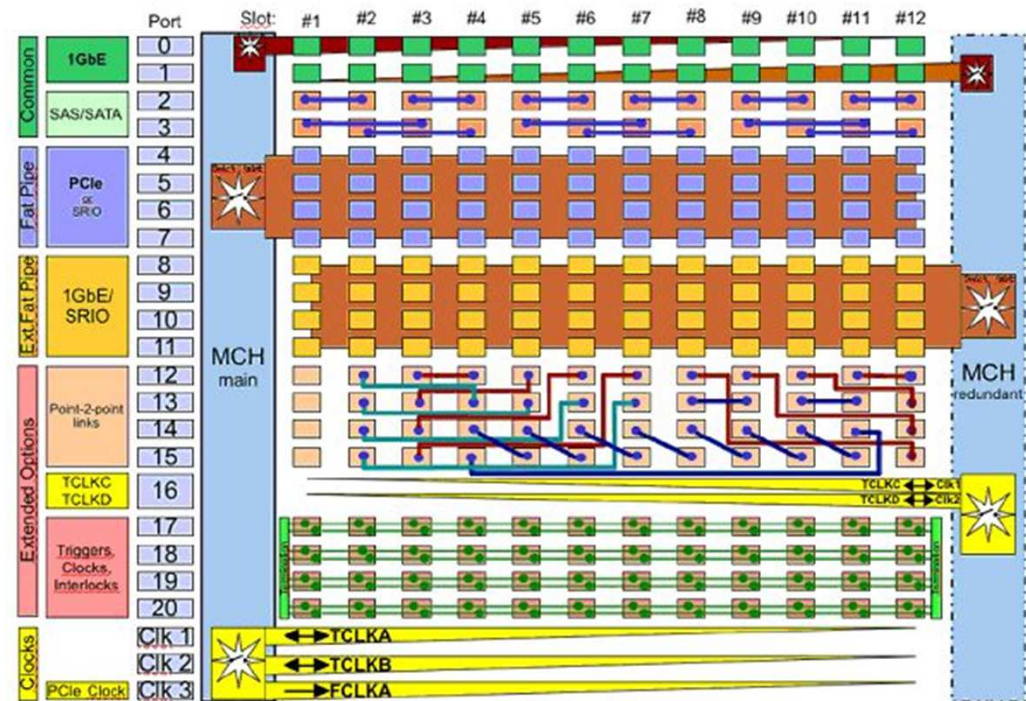

Schroff MTCA.4 Products

Deployment crate for 12 AMC slots

- **Air flow measurements**

- ~ 25 m³/h Front Air flow → > 80 Watts / AMC
- ~ 12 m³/h RTM Air flow → > 40 Watts / AMC

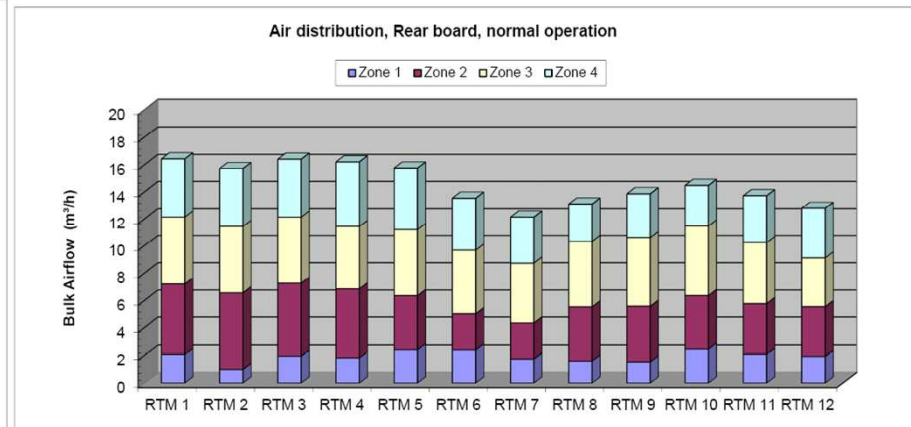
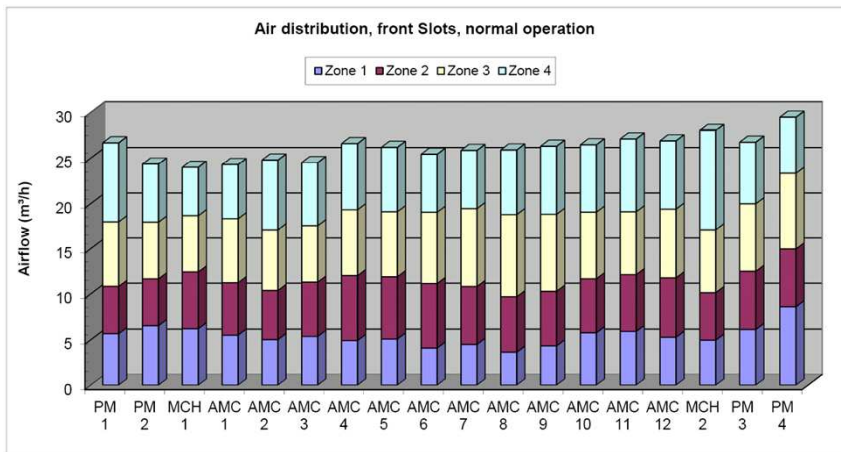
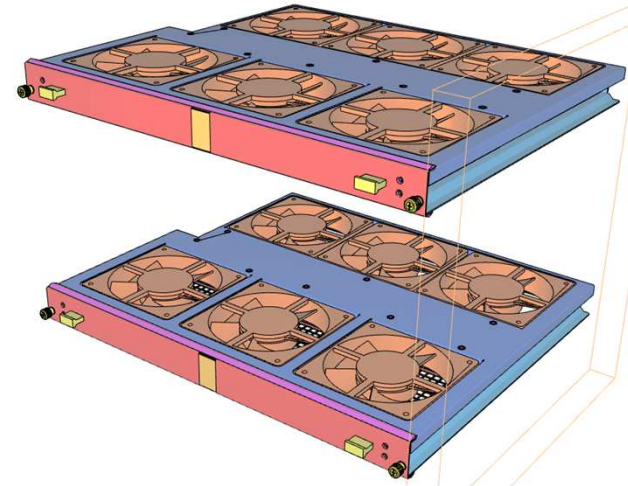

Schroff MTCA.4 Products

Deployment crate for 12 AMC slots

DESY LLRF version

- Based on standard crate 11850-026
- Additional LLRF Backplane for RTM modules
- Customized solution for powerBridge Computer

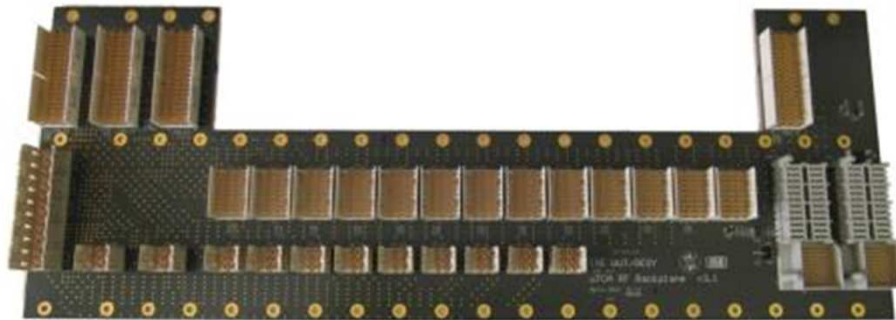

Photo courtesy of DESY / Germany



Schroff MTCA.4 Products

Deployment crate for 12 AMC slots, CERN

- **Front Module Slots:**
 - 12 x AMC slots double, full-size
 - 2 x single PM (Power Module) slots
 - 2 x MCH slots
- **Rear Module Slots:**
 - 6 x RTM slots double, full-size
 - 4 x single PM (Power Module) slots
 - 1 x JSM (JTAG Switching Module)
- **19" wide x Height 7U**
- **Push-Pull cooling with front removable fan trays**
- **Air flow bottom to top**
- **Front removable Air filter**
- **Order information: Schroff P/N 11890-119**

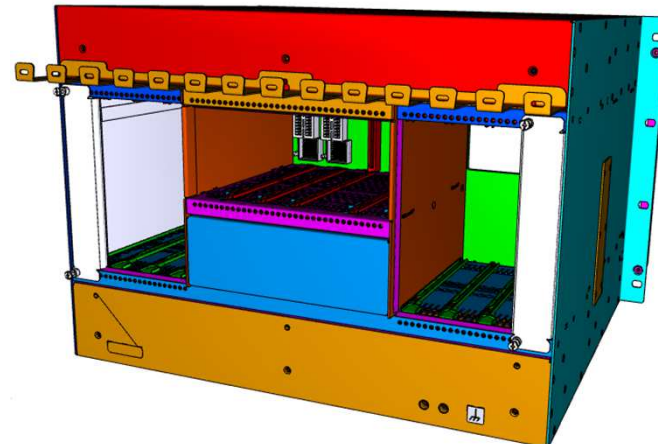

Schroff MTCA.4 Products

Deployment crate for 12 AMC slots

- Common Options: 2 x GbE From Fabric A to all AMC slots
- Common Options: 2 x GbE From Fabric B to all AMC slots
- PCIe x4 between MCH and AMC slots
- Point-to-Point links
- Bussed links for Clock and Trigger signals
- Clock distribution
- JTAG links from JSM to all slots

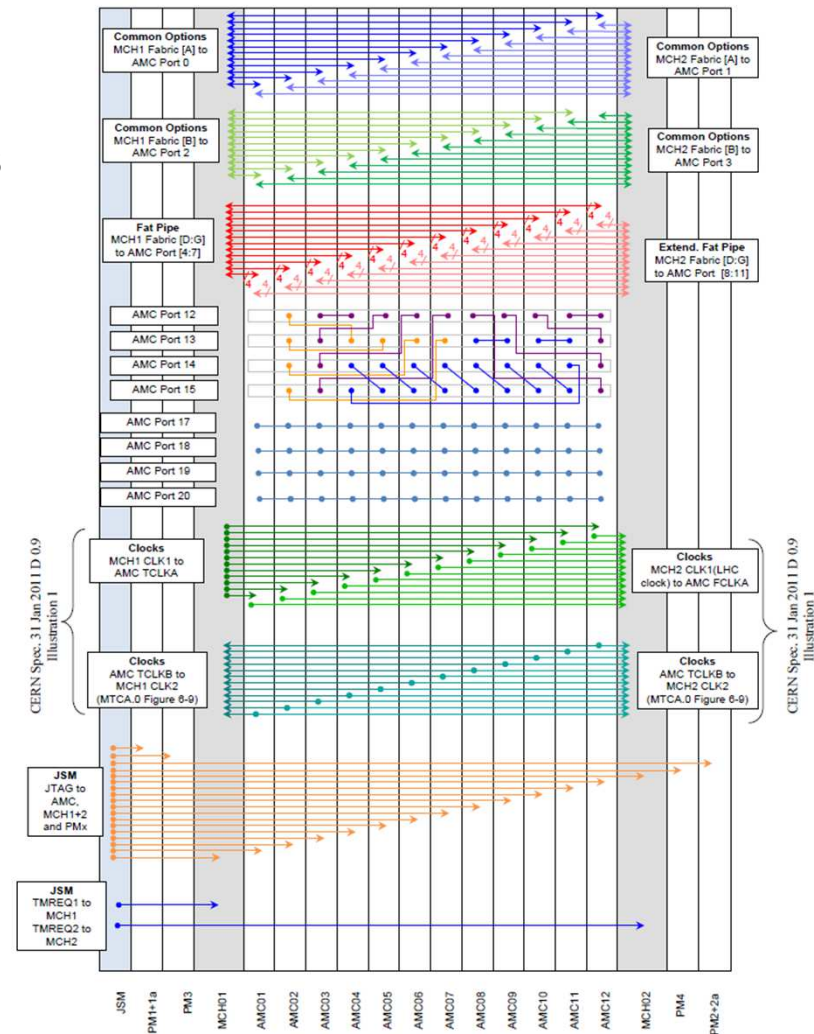

Schroff MTCA.4 Products

Compact 2U 6-Slot MTCA.4 crate

- **Front Module Slots:**
 - 6 x AMC slots double, mid-size
 - 1 x MCA slot
- **Rear Module Slots:**
 - 4 x RTM slots double, mid-size
 - 1 x PM slot
- **Compact: 19" wide x 2U high**
- **Front removable CU including air filter**
- **Two cooling options (with different CUs):**
 - Front to Side
 - Side to Side
- **Customized solution for powerBridge Computer**
- **Order information: Schroff P/N 11890-072**

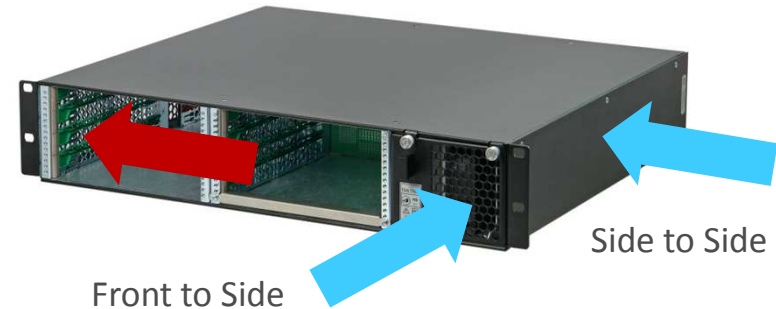

Schroff MTCA.4 Products

Compact 2U 6-Slot MTCA.4 crate, backplane topology

- Common Options: 2 x GbE to all AMC slots
- Direct SATA links between AMC slots
- PCIe x4 between MCH and AMC slots
- Point-to-Point links
- Bussed links for Clock and Trigger signals
- TCLKA
- TCLKB
- PCIe clock

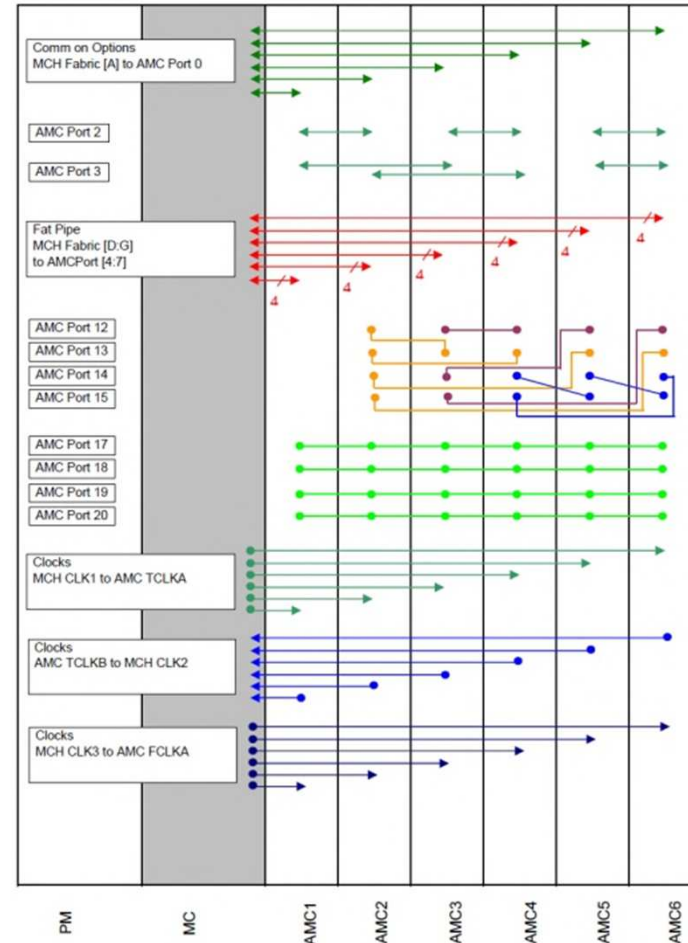

Schroff MTCA.0 Products

Small form factor modular systems

- **AMC 2 Slot System**
 - cooling performance > 100 W
 - Extreme low noise in normal operation
 - Easy removable fan tray and air filter
 - Stackable for lab operation
 - Assembly of mounting plate possible
- **Order information: Schroff P/N 11890-072**
- **Version with built-in MCH in development**



Schroff MTCA.0 Products

Small form factor modular systems, Backplane topology

- 1:1 connection AMC ports 0..20
- Cross connected clock signals
- Fan control circuit
- 12V PP and 3.3V MP

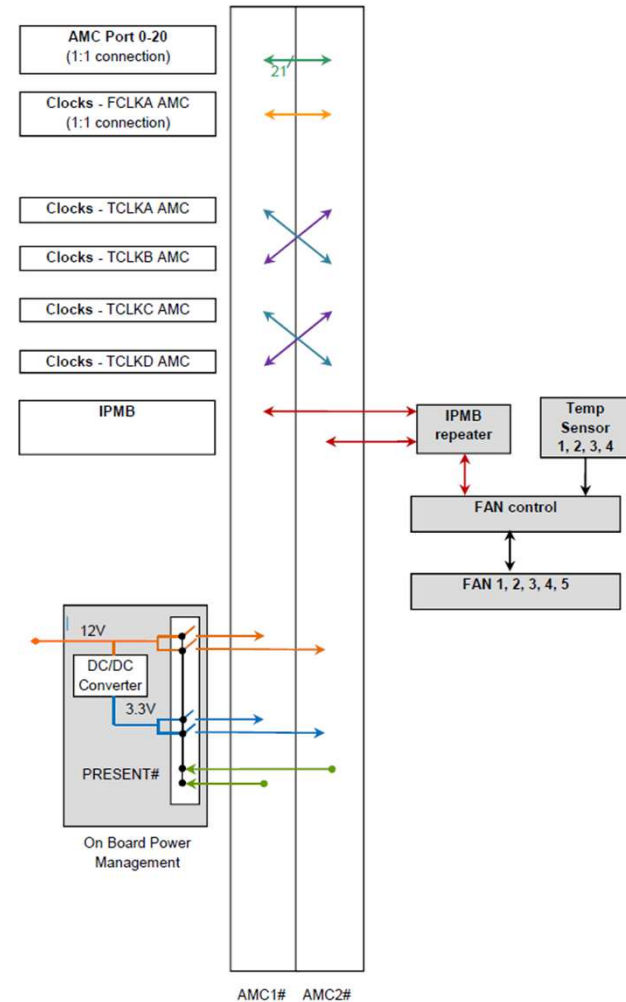

Schroff ATCA Products

- **14U 14 Slot AC Shelves**

- Integrated AC power shelf with up to 3 front pluggable front ends
- 2.7 kW front-pluggable AC Power Supplies with wide range input in a redundant 2+1 configuration
- Electrical Power = 300 W/slot
- The Power Distribution Board (PDB) (1) is located behind the AC PSUs. It provides 3 connectors for the PSUs
- Power distribution is divided into 4 branches. The branches are protected by 40 A fuses



14U 14 Slot Shelf (AC Version)

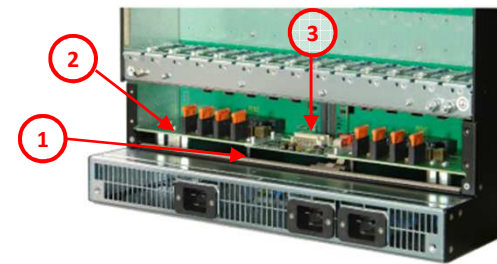

Power Distribution Concept

Schroff ATCA Products

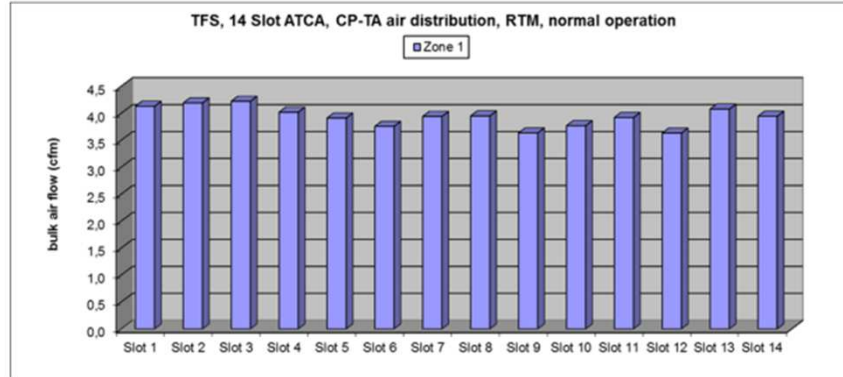
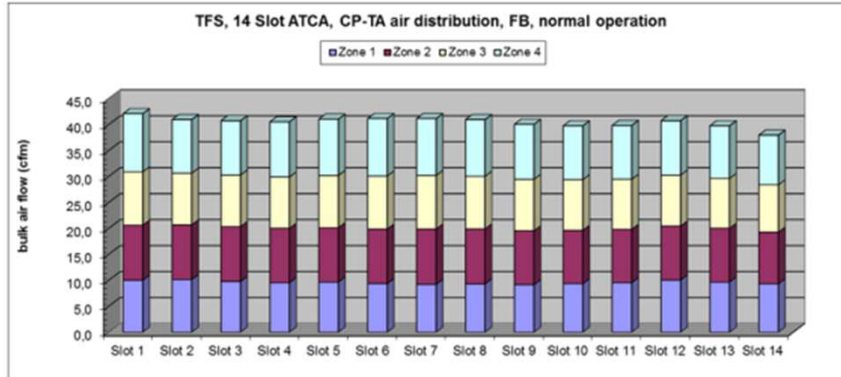

	Zone 1 [cfm]	Zone 2 [cfm]	Zone 3 [cfm]	Zone 4 [cfm]	Σ [cfm]	Σ [m³/h]
Slot 1	10,0	10,6	10,3	11,2	42,1	71,6
Slot 2	10,1	10,6	9,9	10,3	41,0	69,6
Slot 3	9,8	10,6	10,0	10,5	40,8	69,3
Slot 4	9,5	10,5	9,9	10,6	40,5	68,9
Slot 5	9,7	10,5	10,1	10,9	41,1	69,8
Slot 6	9,4	10,5	10,2	11,1	41,2	70,0
Slot 7	9,2	10,6	10,3	10,9	41,2	70,0
Slot 8	9,3	10,6	10,2	10,9	41,0	69,6
Slot 9	9,2	10,4	9,9	10,6	40,0	68,1
Slot 10	9,4	10,3	9,8	10,4	39,8	67,6
Slot 11	9,6	10,3	9,7	10,3	39,8	67,7
Slot 12	10,1	10,4	9,8	10,5	40,8	69,3
Slot 13	9,7	10,4	9,6	10,1	39,8	67,6
Slot 14	9,3	10,0	9,1	9,6	38,0	64,5
Σ	134,2	146,1	138,8	147,8	566,9	963,7

	Zone 1 [cfm]	Σ [cfm]	Σ [m³/h]
Slot 1	4,1	4,1	7,0
Slot 2	4,2	4,2	7,1
Slot 3	4,2	4,2	7,2
Slot 4	4,0	4,0	6,8
Slot 5	3,9	3,9	6,7
Slot 6	3,8	3,8	6,4
Slot 7	3,9	3,9	6,7
Slot 8	4,0	4,0	6,7
Slot 9	3,6	3,6	6,2
Slot 10	3,8	3,8	6,4
Slot 11	3,9	3,9	6,7
Slot 12	3,6	3,6	6,2
Slot 13	4,1	4,1	6,9
Slot 14	3,9	3,9	6,7
Σ	55,1	55,1	93,7

Schroff ATCA Products

- **6U 6 slot combined AC/DC Shelf – side to side cooling**

- 6U 6 slot, triple replicated mesh with bussed or radial IPMI
- Optional Dual Star Backplane with support for DDS Blades
- Side to side cooling (right to left) with redundant fan trays in push-pull configuration
- AC or DC option can be realized with the same chassis by having either
 - AC-Power Supply-PEMs
2.7 kW front-pluggable AC Power Supplies with wide range input in a redundant 2+2 configuration
 - Dual DC PEMs (-48VDC)

first mockup tests have shown a bulk airflow of approx. 1000 m³/h (approx. 590 cfm)



DC Option
Blind panel covering PSU area



AC Option
with 4 PSU; 2,7KW each
(2+2 Redundancy)



DC PEM option



AC Power entry



DC PEM Detail



AC PEM Detail

Schroff MTCA.4 Products

MTCA.4 Filler / Blocker Modules

Rear Module

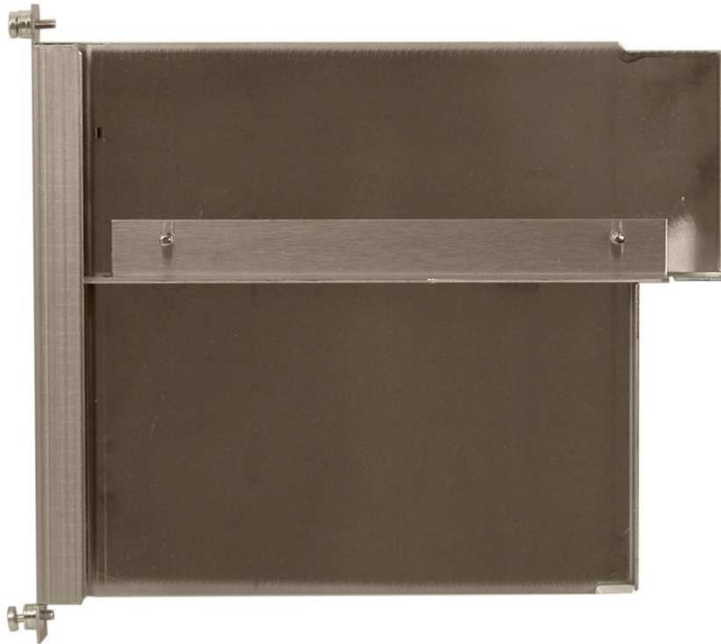

Front Module



Schroff MTCA.4 Products

Front panels and handles

- **Complete kits:**
 - Front panel
 - Handles
 - Light pipes
 - EMC gasket
- **All sizes:**
 - Single / Double
 - Compact / mid / full size

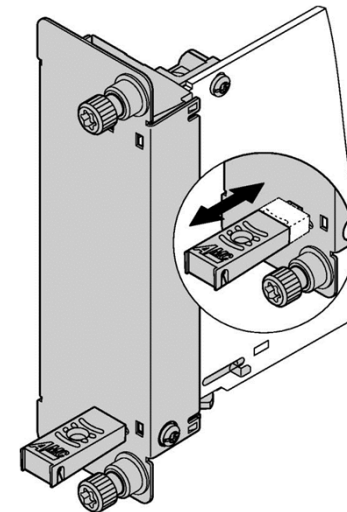
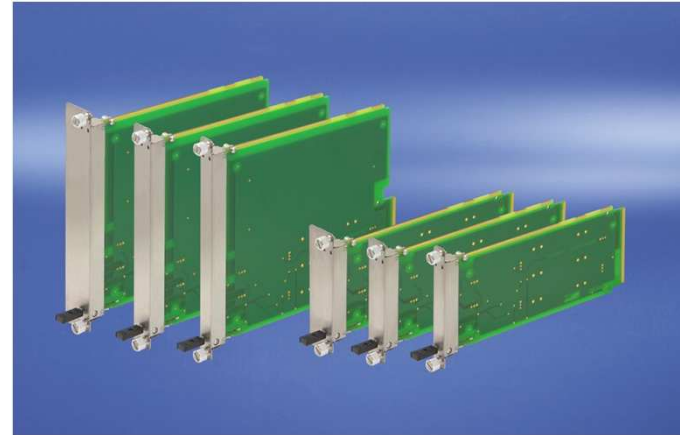

Schroff MTCA.4 Products

Simulation and Testing capabilities

- Thermal simulation
- Climate chamber
- Wind tunnel air flow measurements
- Air distribution measurements
- Acoustic noise measurements
- Backplane simulation and measurement
- Conducted Emissions

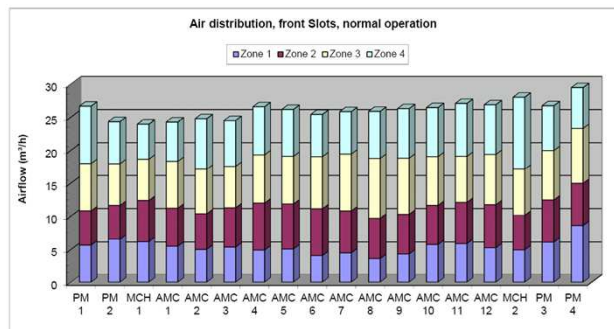
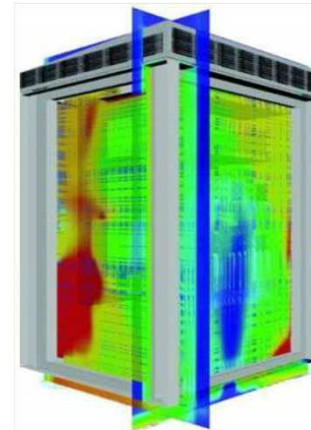

Schroff MTCA.4 Products

PICMG TCA-IW → Interoperability Workshop

- Module and crate manufacturers test the interoperability of their products
- Test matrix defines „who tests with who“
- Last TCA-IW workshops:
 - Schroff, Straubenhardt / Germany in September 2013
 - DESY, Hamburg / Germany in April 2014
 - MTCA.4 crate manufacturers
 - MTCA.4 AMC manufacturers
 - MTCA.4 PM manufacturers
 - MTCA.4 MCH manufacturers

