

承認	検査	設計	校閲	オーダー番号
人	金井	加藤		
版	相田	西野		
			変更	年月日承認
			記事	

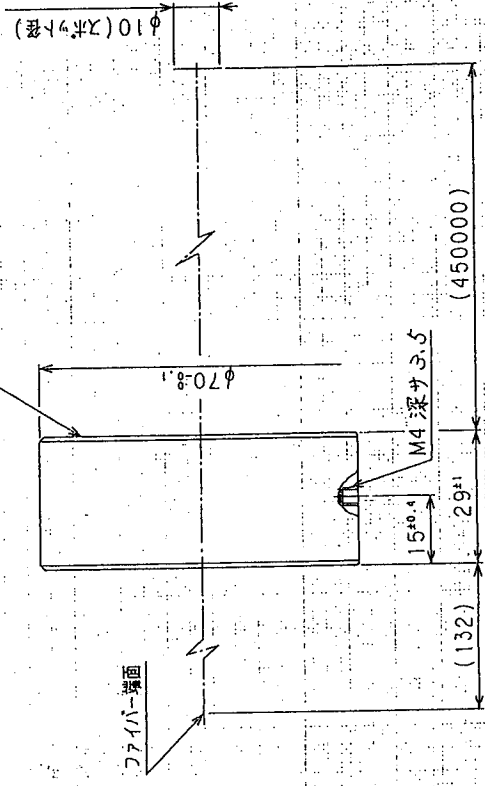

(10) スリット

呼び寸法	普通許容差 (単位:mm)		
	1級	2級	3級
1以下	±0.05	±0.1	±0.2
1 > 20	±0.1	±0.2	±0.4
20 > 50	±0.2	±0.3	±0.6
50 > 100	±0.3	±0.5	±1.0
100 > 200	±0.5	±1.0	±2.0
角	±0.1	±0.2	±0.4

1	キョウトウ	A5056B (JIS H 4040)	1	黒色アルミ付
部号	部品名称	材料及仕様	数量	備考
配作数	材質	製造所	部品名	部番号
必要数	面数C	面名		
一般仕上	階付	名		
位置	R径	符号	部番	部番
		X		
				HC202711

4月9日検査 [合格]



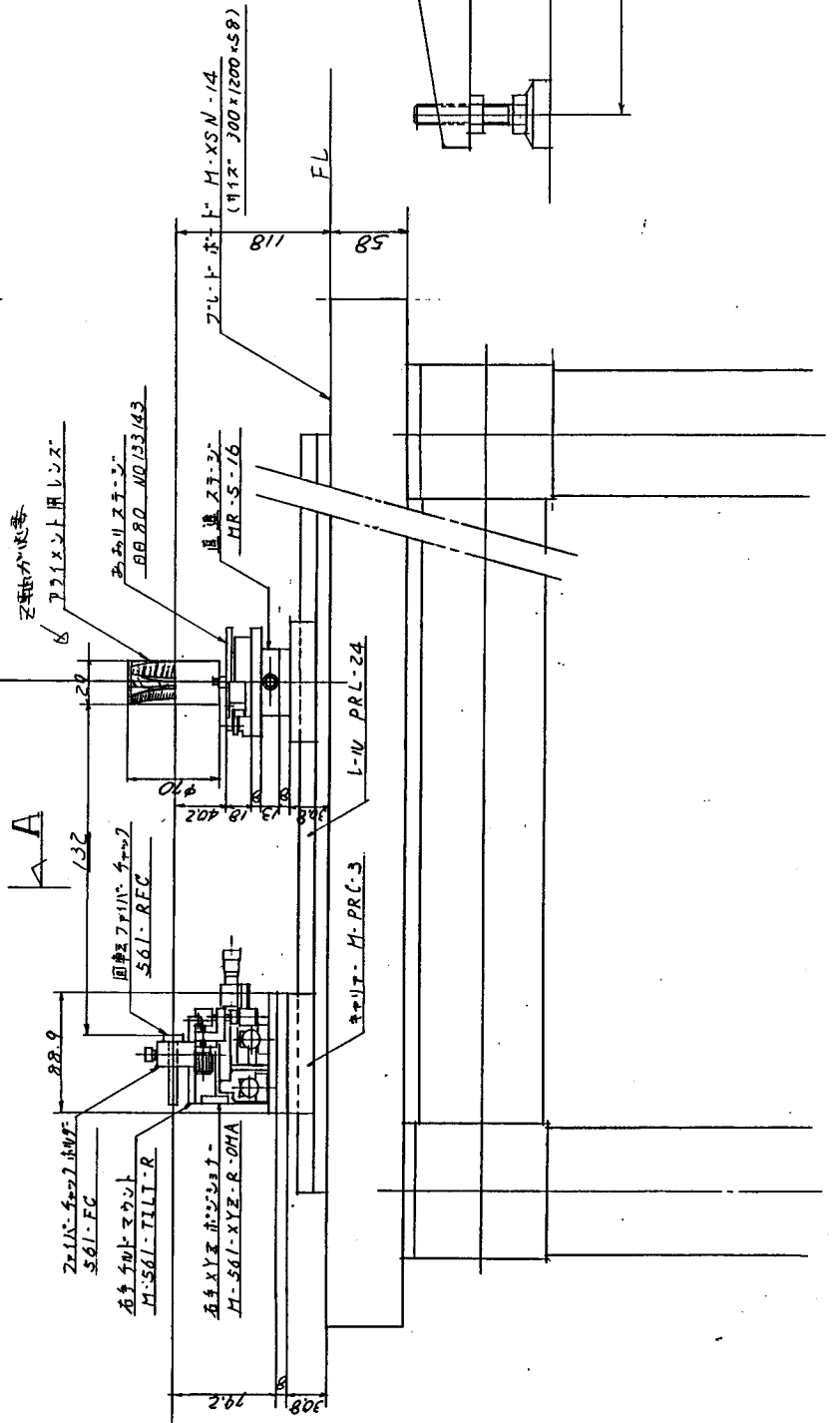
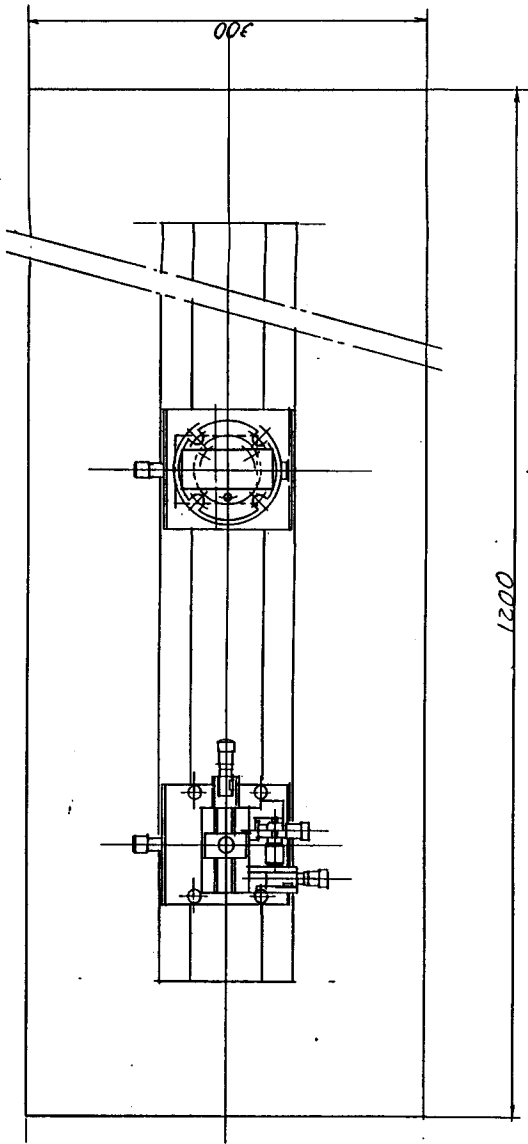
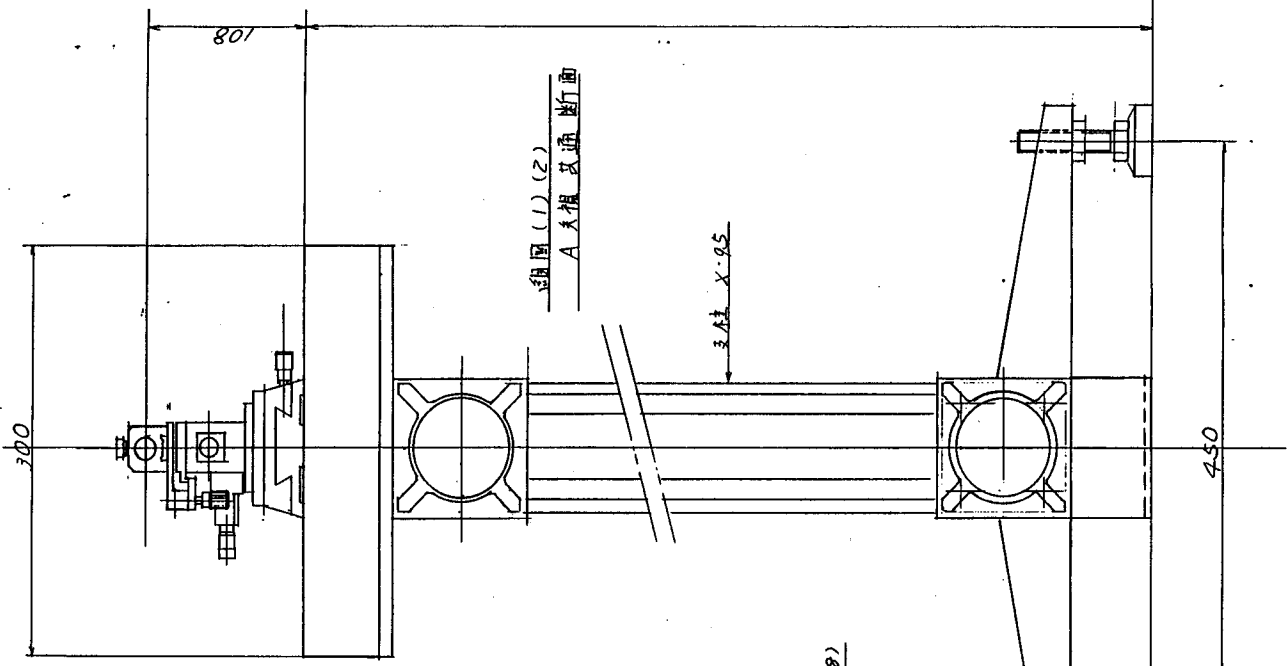

図番	組立図	組立図(2)	組立図(2)	組立図(2)	組立図(2)	組立図(2)
図名	組立図	組立図	組立図	組立図	組立図	組立図
図尺	1/20	1/20	1/20	1/20	1/20	1/20
図種	組立図	組立図	組立図	組立図	組立図	組立図
図号						
図名						
図尺						
図種						
図号						
図名						
図尺						
図種						
図号						
図名						
図尺						
図種						
図号						
図名						
図尺						
図種						
図号						
図名						
図尺						
図種						
図号						
図名						
図尺						
図種						
図号						
図名						
図尺						
図種						
図号						
図名						
図尺						
図種						
図号						
図名						
図尺						
図種						
図号						
図名						
図尺						
図種						
図号						
図名						
図尺						
図種						
図号						
図名						
図尺						
図種						
図号						
図名						
図尺						
図種						
図号						
図名						
図尺						
図種						
図号						
図名						
図尺						
図種						
図号						
図名						
図尺						
図種						
図号						
図名						
図尺						
図種						
図号						
図名						
図尺						
図種						
図号						
図名						
図尺						
図種						
図号						
図名						
図尺						
図種						
図号						
図名						
図尺						
図種						
図号						
図名						
図尺						
図種						
図号						
図名						
図尺						
図種						
図号						
図名						
図尺						
図種						
図号						
図名						
図尺						
図種						
図号						
図名						
図尺						
図種						
図号						
図名						
図尺						
図種						
図号						
図名						
図尺						
図種						
図号						
図名						
図尺						
図種						
図号						
図名						
図尺						
図種						
図号						
図名						
図尺						
図種						
図号						
図名						
図尺						
図種						
図号						
図名						
図尺						
図種						
図号						
図名						
図尺						
図種						
図号						
図名						
図尺						
図種						
図号						
図名						
図尺						
図種						
図号						
図名						
図尺						
図種						
図号						
図名						
図尺						
図種						
図号						
図名						
図尺						
図種						
図号						
図名						
図尺						
図種						
図号						
図名						
図尺						
図種						
図号						
図名						
図尺						
図種						
図号						
図名						
図尺						
図種						
図号						
図名						
図尺						
図種						
図号						
図名						
図尺						
図種						
図号						
図名						
図尺						
図種						
図号						
図名						
図尺						
図種						
図号						
図名						
図尺						
図種						
図号						
図名						
図尺						
図種						
図号						
図名						
図尺						
図種						
図号						
図名						
図尺						
図種						
図号						
図名						
図尺						
図種						
図号						
図名						
図尺						
図種						
図号						
図名						
図尺						
図種						
図号						
図名						
図尺						
図種						
図号						
図名						
図尺						
図種						
図号						
図名						
図尺						
図種						
図号						
図名						
図尺						
図種						
図号						
図名						
図尺						
図種						
図号						
図名						
図尺						
図種						
図号						
図名						
図尺						
図種						
図号						
図名						
図尺						
図種						
図号						
図名						
図尺						
図種						
図号</						

2/2 AM 9:05 3号館へ転送したのでこのエラーに付してため  
原紙を送り附 FAX 発信用紙

( 1/2 )

高エネルギー物理学研究所

入射器 小川 殿  
FAX 0298-64-2801

94年2月1日  
浜松ホトニクス株式会社  
固体営業部 文塚  
TEL 053-434-3311(代)  
FAX 053-434-5184

貴下益々ご繁栄のこととお慶び申し上げます。  
毎度格別のお引立てを賜り厚く御礼申し上げます。

記

前略、ビーム位置検出用素子の検討に伴、当方の資料は  
別紙の様で 4分割素子での検討中も残っております。  
経過の詳細は記録が利ませんか PSDでの検討としては  
記録に利ませぬで当初は 分割型素子で進めていたと  
思っております。

添付致しますのはこの時当方で作図したものが  
取付け穴位置も、材質(4-2)など、最終まで進めて  
おきますと思っております。

取り急ぎ検討の為送付致します。

真々

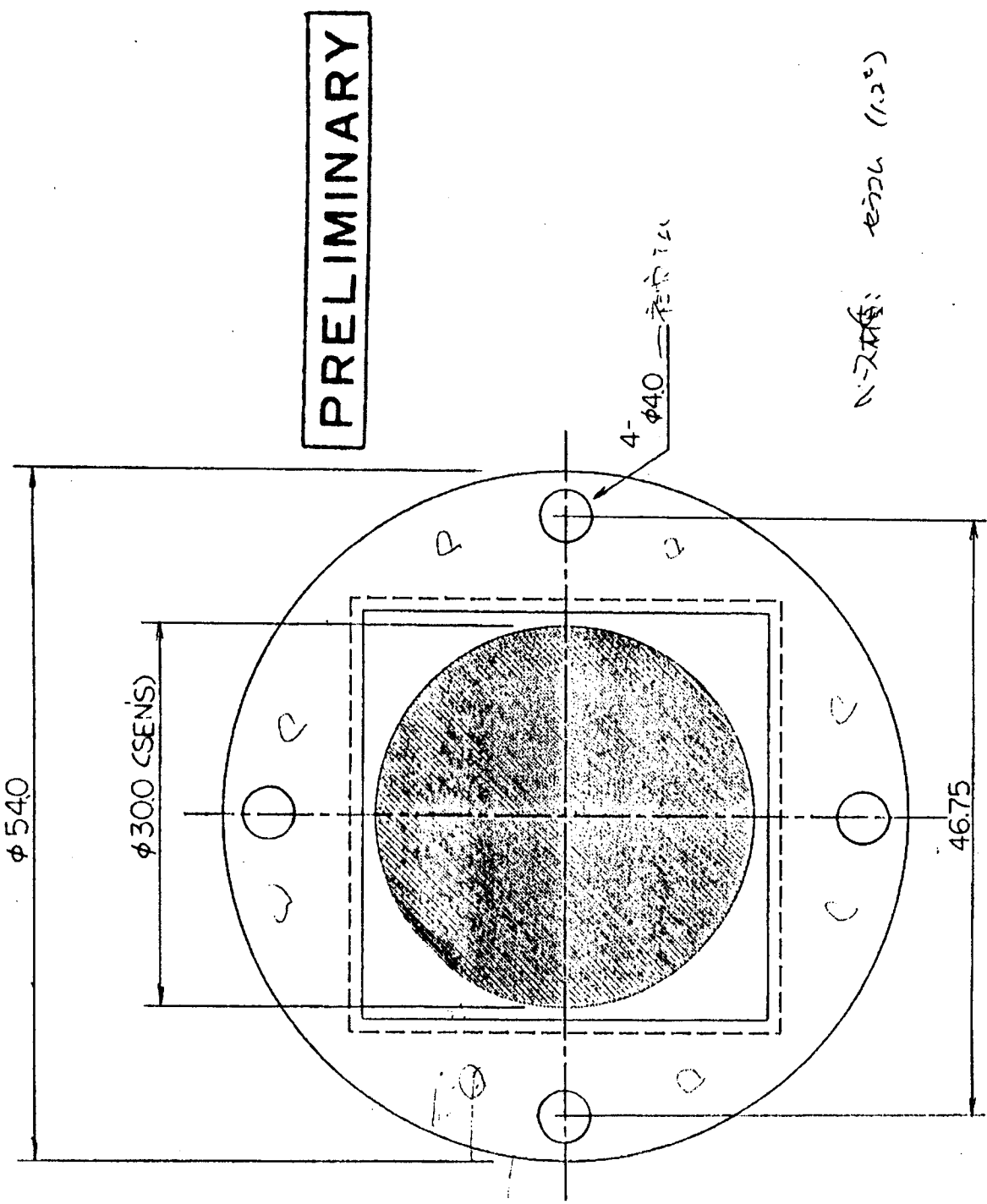

PRELIMINARY

N-2744: せつらん (1.2%)

浜松ホトニクス株式会社

ファックス通信	文書No.	平成6年 / 月 / 日	総枚数 / の / 枚目
FAX No. _____ 宛先 文部省高工研一物理学研究所 放射実験施設 小川 様		<b>伯東株式会社</b> <input checked="" type="checkbox"/> 本社 〒160 東京都新宿区新宿1-1-13 TEL 03-3225-8910 <input type="checkbox"/> 虎ノ門別館 〒105 東京都港区虎ノ門1-2-29 TEL 03-3225-8910 <input type="checkbox"/> 伊勢原事業所 〒259 神奈川県伊勢原市鈴川42 TEL 0463-94-8910 <input type="checkbox"/> 東北営業所 〒980 仙台市青葉区上杉1-4-10(上杉古久根ビル) TEL 022-224-8910 FAX 022-224-0645 <input type="checkbox"/> つくば営業所 〒300-05 茨城県稲敷郡江戸崎町大字羽賀1849 TEL 0298-92-5500 FAX 0298-92-1414  <input type="checkbox"/> オフテイクス 部門 <u>GG</u> 氏名 <u>佐々木</u> FAX _____ (部門別に番号が異なります)	
件名 <u>アケエ-交換の件</u>			

いりお世話になります。上記件につきご連絡致します。

- 作業内容。トシ内アケエ-7-を交換
- 取り除いたアケエ-7-を地上の施設に取り付けます。

○日程。1/20(木)を予定します。先生のスケジュールは、いかがでしょうか。  
(9:30)

事業所が務店になりましたので、総務課でこの紙面に2回ご連絡  
致します。

〒160 東京都新宿区新宿1-1-13

TEL 03 3225 8910 代表  
03 3225 8976 ファクシムル  
FAX 03 3225 9012

以上 早急にお返し申し上げます。

1993 (平成5年) 12月20日

1/6

伯東オプティクス(株)

田中様

高エネルギー物理学研究所  
放射光入射器 (J-1)



**KEK** NATIONAL LABORATORY  
FOR HIGH ENERGY PHYSICS

---

〒305 茨城県つくば市大穂1-1  
Phone 0298-64-1171 (代表)  
Phone 64-5691 (直通)  
FAX 0298-64-7529

アライメント光学系  
重工fax copy / Laser資料

本紙を含む 6 頁のFAXをお送りしますので、  
宜しくお願い致します。

田中様

重工の飯野さんのX線のcopy及び別のLaser (Adlas) の  
資料をお送りします。よろしくお返事ください。

J-1

- 着信の確認返答をお願い致します
- 関係者に配付をお願い致します
- 至急扱い

KEK 放射線入射器 小川 様

93.12.18

名航 俊野

入射器アライメントシステムの件

1. レーザーの安定度確保

(1) 気流によるからズレ

(レーザー管の設置対策)

ファイバー束光源・射出束共に  
フットが1必要だと思います。

(位置の調整メカはフットの外  
側から操作したい。)

(2) 振動対策

同上のものを防振台に乗せる。

(3) 整列策

レーザー管の設置サポート?

2. 光軸合せ作業

ファイバー射出束の架台全体を動かして加算ユニット  
平均ラインに合わせる作業が楽に出来る様な位置  
調整メカが必要です。

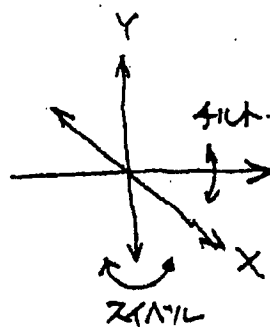

X・Y・スライル・フィルが  
独立していること。

( Y → フィル → スライル → X )  
の順序が良い。

3. 真空ダクトとの関係

ファイバー射出束を去るだけ光軸管のガラス窓に  
接触させたい。  
(真空ダクト)

架台設計時に配慮が必要。

(以上)



# Diode Pumped Solid State Lasers

**\*ADLAS**  
advanced design lasers

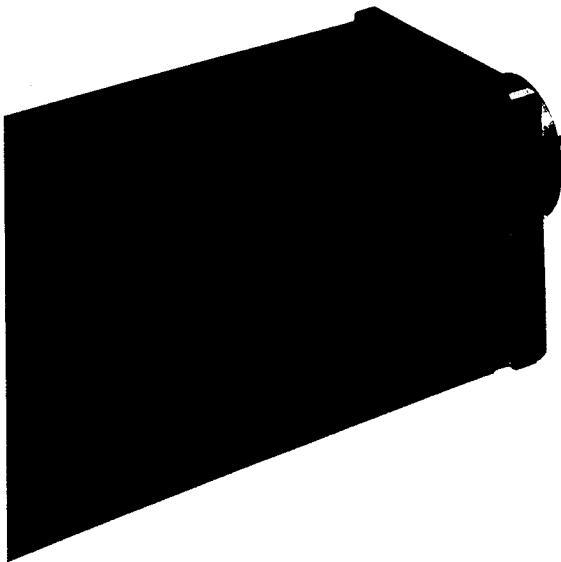

## Specifications

### diode laser pumped solid state lasers 532 nm cw, Nd:YAG, single longitudinal mode

Technical Data	105 II	205 II	305 II	315 II	325 II	425 II
wavelength (nm)	139 x 103 = 14283 532					
cw output power (mW)	> 10	> 20	> 50	> 100	> 150	> 400
transversal mode/ roundness of beam	TEM <sub>00</sub> (>95%) / < 1.1 : 1.0					
TEM <sub>00</sub> beam diameter, typical (mm) (1/e <sup>2</sup> ) at beam waist	0.32 *					
TEM <sub>00</sub> beam divergence (mrad) (1/e <sup>2</sup> )	2.2 *					
beam pointing stability (% of beam divergence)	< 1.0					
stability of output power over 8 hrs (%)	< ±2 (typical 0.5)					
noise (<10Hz to >1GHz)(% rms)	< 0.5 (typical 0.1)					
polarization	linear 100:1, vertical					
inherent linewidth	< 10 kHz					
jitter	<± 500 kHz					
drift	< 100 MHz/h (ΔT <±1 °C)					
operating voltage	110/220V AC ±10%					
power consumption	< 80W (typ.40W)			<200W (typ.100W)		<300W (typ.150W)
ambient temperature range for operation	0-35°C (32-95°F)**					
laser head heat sink temperature for conductive cooling	0-55°C (32-130°F)					
dimensions of laser head mm (inches), weight	275x55x51 (10.8x2.6x2.0) 1.2 kg			335x89x80 (13.2x3.5x3.1) 6.5 kg		
dimensions of power supply mm (inches), weight	215x105x170 (8.5x4.1x6.7) 4 kg			440x260x130 (17.3x10.2x5.1) 13 kg		

Vibration, shock (IEC 68)

Design and technical data are subject to change without notice.

\* factory provided collimating optics on request

\*\* with factory provided or other adequate heat sink

**optional:** micro-processor control unit with RS 232 interface (215 x 105 x 45 mm)

*warm up time 5 min*

Replacing tubes with semiconductors

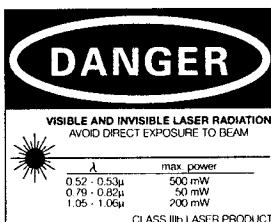

ADLAS GmbH & Co.KG  
Seelandstraße 67  
23569 Lübeck, Germany  
Tel. ...49-451-3909300  
Fax....49-451-3909399

ADLAS, Inc.  
636 Great Road  
Stow, MA 01775, USA  
Tel.: (508) 897-0800  
Fax: (508) 897-0811

100/200/300-series

laser head

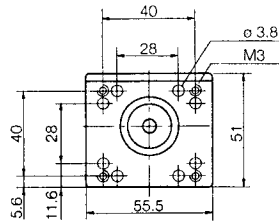

heat sink

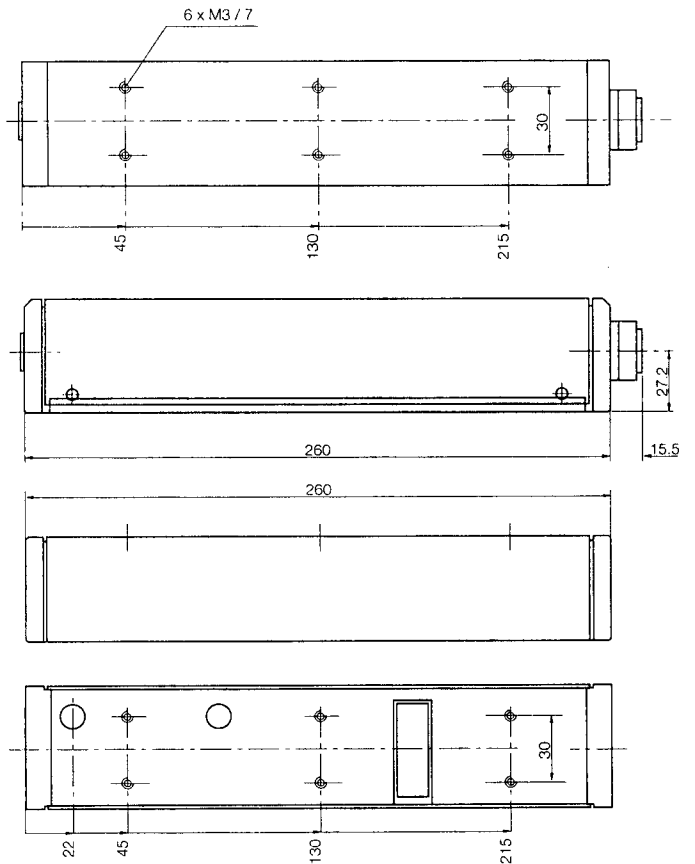
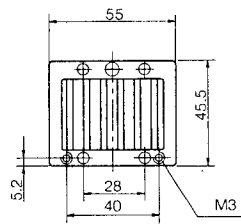

320/420-series

laser head

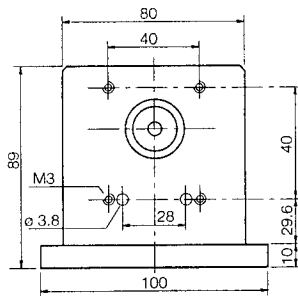

heat sink

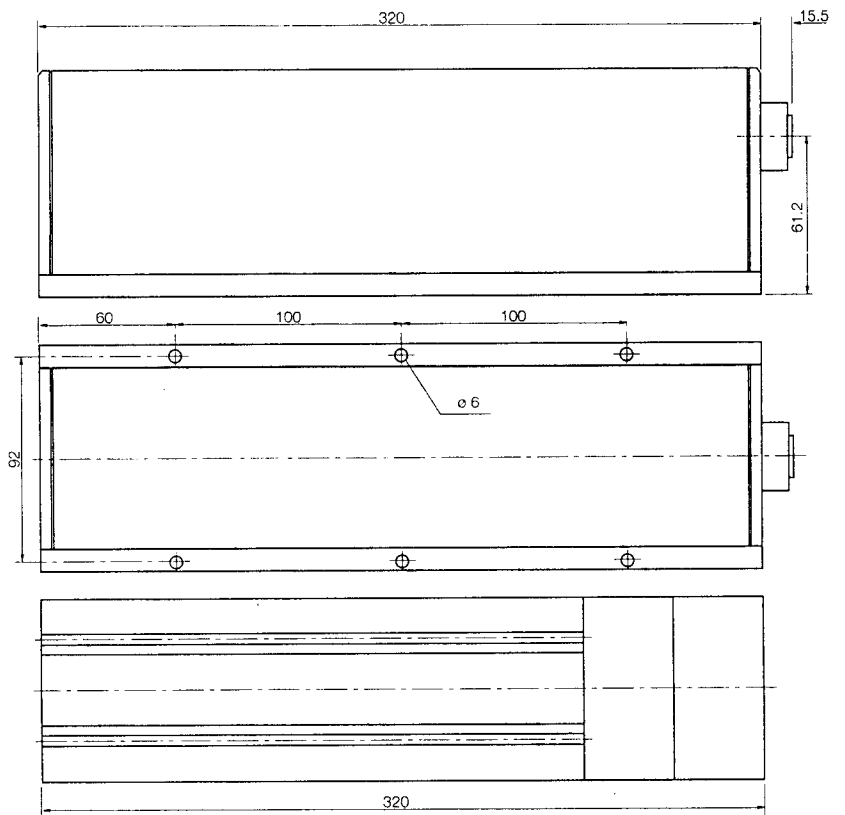
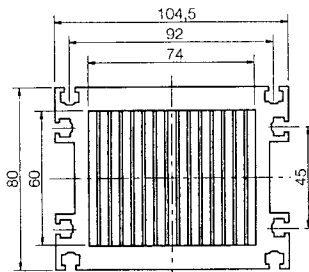

**532 nm cw, Nd:YAG, single longitudinal mode**

## Diode Pumped Solid State Lasers

ADLAS manufactures diode pumped solid state lasers for a wide range of scientific and OEM applications. In power performance and beam quality our lasers demonstrate considerable advantages over other lasers. The principle choice of a laser diode pump over conventional lamp pumping is based on solid reasons: the narrow emission bandwidth of the diode laser matches the absorption band of the Nd:YAG crystal (see diagram to the right). Temperature stabilization of the carefully selected diode laser guarantees that the ideal wavelength of 808 nm is constantly maintained.

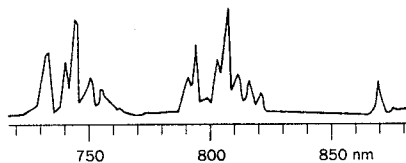

absorption band of Nd:YAG laser

ADLAS lasers feature a special pumping configuration (see schematic below) which offers several advantages: low pump power loss through direct coupling, high efficiency through mode matching of the pump and Nd:YAG laser beams, and a compact, rugged design. The high power, low beam quality pump light of the diode laser is efficiently converted (typ. 35%) to the diffraction limited output of the solid state laser. Additional noteworthy features are the low power requirement and the long, maintenance-free lifetime.

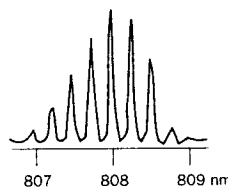

emission spectrum of diode laser

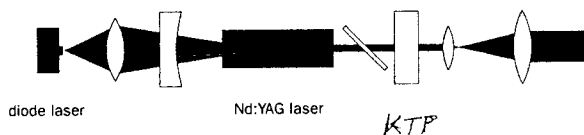

Diode pumped solid state lasers from ADLAS are cost effective in procurement and operation. Their stability and compactness make them perfectly suited to many purposes, and, as a result of their near-perfect beam quality, destined for maximum performance applications.

代理店

antex 福井氏 or 田野氏

3226-6321

micro processor

**ADLAS**  
advanced design lasers

32700

福井 autex 03-3226-6321  
autex

(12)

11/18  
T-2

2/18

2.2(2) 2/28

# ADLAS: Effective Laser Solutions

Diode pumped solid state lasers manufactured by ADLAS have provided solutions for many applications:

- spectroscopy
- metrology
- holography
- interferometry
- wafer inspection/-processing
- micro-material processing
- range finding
- medicine (diagnostic/therapeutic)
- printing
- light scattering (static/dynamic)
- particle counting
- photoluminescence
- signal transmission

and many more. Commercially viable solutions for further applications are under development.

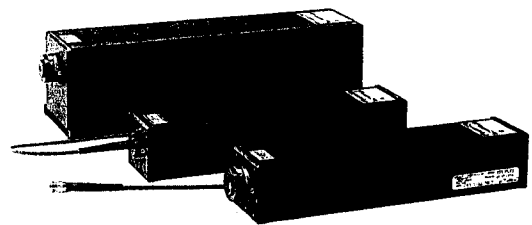

## Biotechnology

Biotechnology, a highly dynamic scientific-technological sector, requires new tools of extraordinary quality and precision. Typical applications for ADLAS lasers are "optical tweezers" (trap, hold, and move micron size particles), confocal microscopy, fluorescence excitation, cell counting and cell sorting.

Good reasons to choose ADLAS lasers:

- excellent focussability due to a near-perfect Gaussian laser beam
- high beam pointing stability
- very stable output power level
- easily adapted as add-on (e.g. to microscopes)
- compact design
- operable in any position



TEM<sub>00</sub> beam of an ADLAS laser

## General Specifications

Beam quality	TEM <sub>00</sub> ( $M^2 < 1.05$ )
polarization	linear > 100 : 1
noise (10 Hz - 1 GHz)	< 0.5 % rms (typ. < 0.1 % rms)
output power stability (8 h time period)	< ±2 % (typ. < ±0.5 %)
repetition rate of q-switched laser	from single shot to 50 kHz* (infrared QS lasers can be switched to cw operation)
beam pointing stability	< 1 % of beam divergence

\*(reduced pulse energy for repetition rates >1 kHz)  
Detailed specification sheets are available.

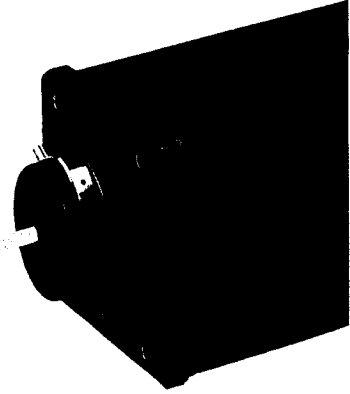

## General features of ADLAS lasers

- compact, rugged design
- no high voltage
- sealed cavity design
- high efficiency
- air cooling (no liquids)
- extraordinary beam quality
- highly stable output power
- long coherence length
- TEM<sub>00</sub> mode
- high signal-to-noise ratio
- low power requirement
- maintenance-free
- minimal operating costs
- long lifetime

## Test and Measurement

Test and measurement technology applications call for more specifically tailored laser products than ever before. ADLAS currently offers about 40 different approved and tested standard lasers, for example the q-switched lasers with ns pulses for range finding and the frequency doubled cw lasers with extremely long coherence length for non-destructive testing (holography, ESPI and shearography). Further applications are in spectroscopy and interferometry.

Good reasons to choose ADLAS lasers:

- very long coherence length
- short warm-up time
- excellent temperature stability
- rugged construction
- quiet operation
- air cooling
- compact design
- adjustable output power



Courtesy of Fraunhofer-Institute IPT, Aachen\*

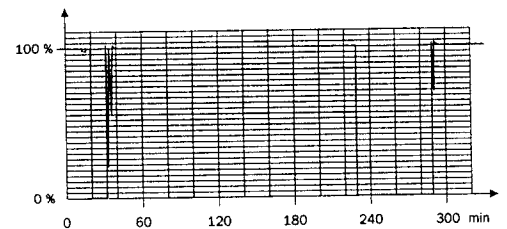

typical warm-up behavior of DPY 315 II (on/off test cycles)

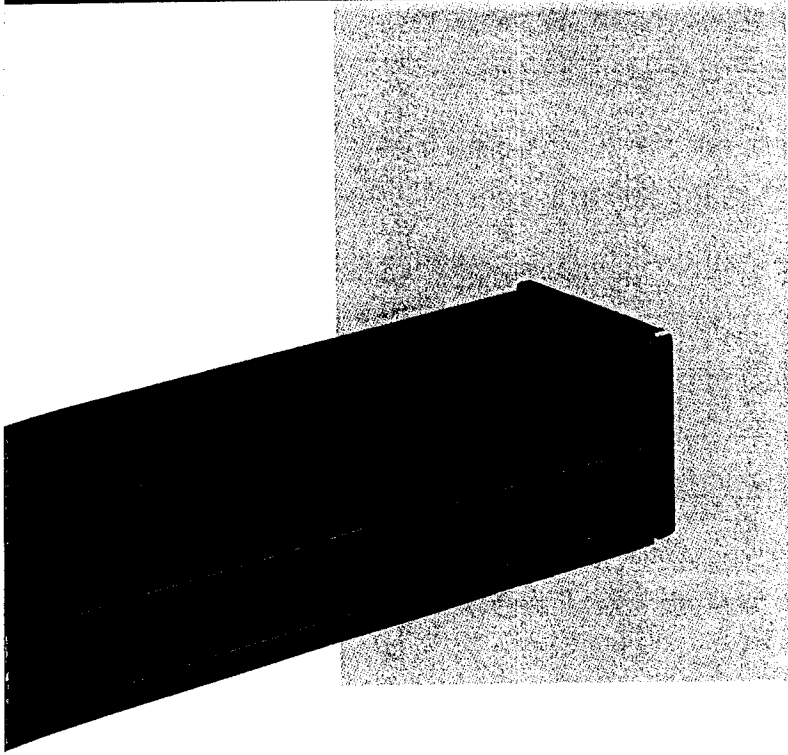

## Product Overview

### cw Lasers IR

1064 nm	50 mW - 3000mW
1313 nm	40 mW - 800 mW

### cw Lasers VIS, SLM

532 nm	10 mW - 400 mW
--------	----------------

### cw Lasers IR, SLM

1064 nm	20 mW - 600 mW
---------	----------------

### Q-Switched Lasers

	models up to:	
1313 nm	>100 $\mu$ J	<70ns
1064 nm	>200 $\mu$ J	<20ns
1047 nm	>350 $\mu$ J	<20ns
532 nm	>60 $\mu$ J	<17ns
523 nm	>120 $\mu$ J	<17ns
349 nm	>40 $\mu$ J	<13ns
262 nm	>20 $\mu$ J	<13ns

### Options

- C-mount
- microprocessor control with RS 232 interface (532 nm cw models only)
- adjustable output power
- polarization preserving SM fiber pigtail
- 30 dB isolator integrated in laser head (1313 nm cw models only)

## Communication

Applications in the communications industry, cable television (CATV), broadband transmission, antenna remoting etc. provide a growing market for solid state lasers. ADLAS meets this demand by supplying lasers with integral optical isolators and permanently coupled fiberoptic pigtails. A cost-effective transmission system utilizes an ADLAS Nd:YLF solid state laser (1313nm) in conjunction with an external modulator. This type of system configuration, with its high output power, substitutes the need for several directly modulated systems at a lower cost.

Good reasons to choose ADLAS lasers:

- long lifetime (design for >10 years available)
- single line operation
- distortion free signal
- TEM<sub>00</sub> mode
- high signal-to-noise ratio
- polarization preserving coupling

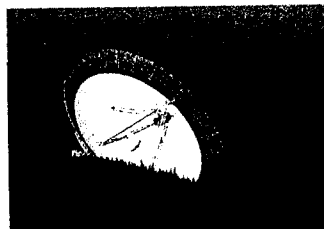

## Printing

In the printing industry, computer typesetting and raster image processing call for constantly shorter production times and ever increasing resolutions. The latest generation of printing plates are now able to be imaged directly. The printing environment offers many challenges to the components involved (vibrations, large temperature fluctuations). Our factory sealed resonator and its robust construction uniquely qualify ADLAS lasers to meet just such special requirements.

Good reasons to choose ADLAS lasers:

- low noise for clearly better exposure results
- no periodic fluctuations, smooth transitions
- excellent beam pointing stability
- simple cooling requirements
- low power consumption/heat load
- high output power for shorter exposure cycles

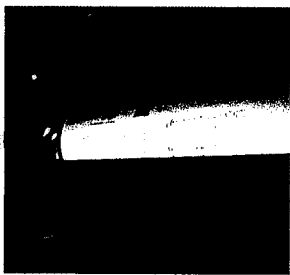

## Material Processing

ADLAS q-switched lasers are well suited for material processing applications where micron precision is needed. Resistor trimming, flat panel display repair, silicon wafer marking, ASIC chip production and tuning of quartz crystals are just a few examples of ADLAS lasers on the production line. Coincidentally, every second quartz watch manufactured in Europe has been tuned with an ADLAS laser. As most of these processes take place in a Clean Room environment the benefits of maintenance-free, no-water operation, of the compact design and of an extremely small footprint become obvious.

Good reasons to choose ADLAS lasers:

- superior beam quality
- short, high energy pulses
- excellent pulse-to-pulse stability
- ease of operation

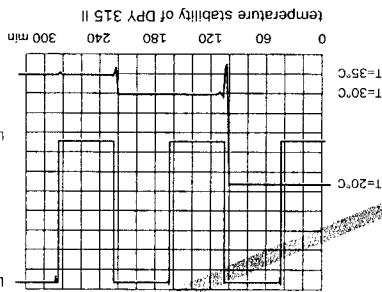

**ADLAS**  
advanced design lasers



## High Quality Products

QUALITY is of utmost importance to us at ADLAS. Quality management is an integral part of all functions within the company. Early failure recognition and avoidance procedures are being followed from the conceptual phase all the way to the finished product.

### Design

Product design balances stringent component quality standards with cost effectiveness. Specific customer requirements can be addressed during this phase.

### Development

Our engineers constantly evaluate components, products and applications to assure the quality standards demanded by the user. This process also leads to ongoing improvement of existing products.

### Documentation

To assure the product integrity each product platform is completely documented. Our internal configuration control will update changes immediately. Therefore all data and documentation to the component level are readily accessible.

### Environmental Testing

ADLAS lasers are designed to withstand harsh environmental conditions. Each model is subjected to rigorous EMI, shock and vibration as well as temperature testing.

### Production

All components and parts manufactured by outside vendors undergo critical incoming tests. Test procedures are fastidiously followed and results are recorded. Only parts meeting our requirements are stocked for use.

Specific assembly and handling routines help to protect sensitive components from damage through ESD, contamination, etc. during the manufacturing process. Critical components are documented on individual test records. Quality Circles and scheduled staff training courses are designed to raise the overall quality consciousness of our personnel. Assembly of critical components is conducted in our Clean Room facilities. Measurement instruments are under constant control and routine calibration.

### Final Test

Each individual unit is tested to meet the key parameters of output power, polarization, beam quality, etc.. In addition, each laser is tested over an extended burn-in time under real operating conditions.

The persistently high level of quality awareness during development and manufacturing is the foundation of highly reliable, maintenance-free ADLAS lasers.

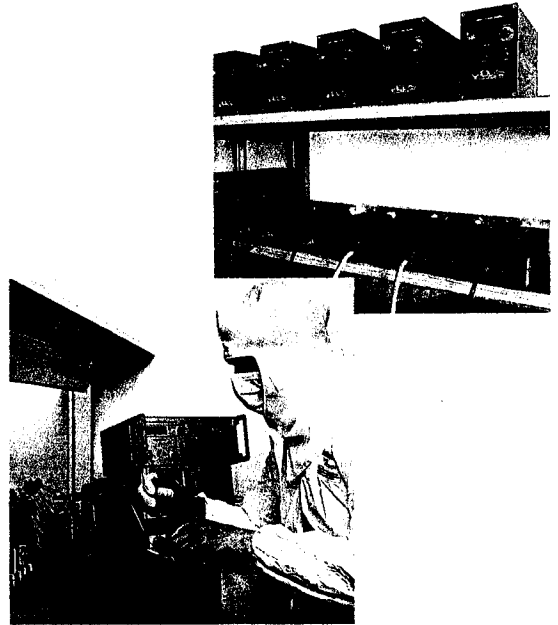

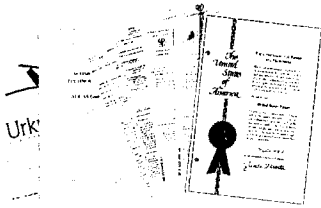

### Milestones

- 1986: Incorporation of ADLAS Germany by Dr. Steyer and Dr. Kortz, both with many years of experience in development, production, and marketing of lasers.
- June 1986: world's first commercial diode pumped Nd:YAG laser product with 40 mW of TEM<sub>00</sub> output power.
- 1987: first commercial frequency doubled DPY with 2 mW of output power.
- 1988: first ADLAS q-switched laser
- 1989: optical output power IR/VIS increased to 350/80 mW.
- 1990: 750 mW/140 mW IR/VIS optical output power
- 1990: single longitudinal mode laser with 1 W output power and a linewidth of 10 kHz/10 ms.
- 1992: Incorporation of ADLAS, Inc. USA in Stow, MA
- 1993: 3000 mW/400 mW IR/VIS optical output power, more than 350 μJ q-switched pulse energy in the IR

### Corporate Mission

ADLAS specializes in the development and production of diode laser pumped solid state lasers. ADLAS invests more than 20% of corporate revenues in the continued research and development of innovative pumping concepts and optimized laser configurations. ADLAS sees itself as a manufacturer of OEM laser light sources, capable of providing special lasers to fulfill the needs of our customers. ADLAS develops, assembles and tests all components in house. Active contact with both our customers and suppliers provides the flexibility to react to market requirements with optimally tailored products.

### Corporate Goals

- Further miniaturization and power extension of our solid state laser products.
- Expansion of our leading market position as a supplier of diode pumped laser sources.
- Continually ensure the high level of our product quality.
- Adaption of our diode pumped solid state lasers to meet the requirements of new applications.



ADLAS GmbH & Co.KG  
Seelandstr. 67  
23569 Lübeck, Germany

ADLAS, Inc.  
636 Great Road  
Stow, MA 01775, USA

Tel. . . 49-451-3 909 300  
Fax . . 49-451-3 909 399

Tel. : (508) 897-0800  
Fax: (508) 897-0811

\*Photograph: Ernsting/Bilderberg