



Progress of Injector Linac

**Kazuro Furukawa
for Injector Linac**



- ◆ 概要
- ◆ Alignment
- ◆ 電子銃
- ◆ RF 電子銃
- ◆ 熱電子銃
- ◆ 陽電子発生装置
- ◆ Schedule



Linac Upgrade Overview

Mission of electron/positron Injector in SuperKEKB

◆ 40-times higher Luminosity

❖ Twice larger storage beam

→ Higher beam current at Linac

❖ 20-times higher collision rate with nano-beam scheme

✧ → Low-emittance even at first turn

→ Low-emittance beam from Linac

✧ → Shorter storage lifetime

→ Higher Linac beam current

◆ Linac challenges

❖ Low emittance e^-

✧ with high-charge RF-gun

❖ Low emittance e^+

✧ with damping ring

❖ Higher e^+ beam current

✧ with new capture section

❖ Emittance preservation

✧ with precise beam control

❖ 4+1 ring simultaneous injection

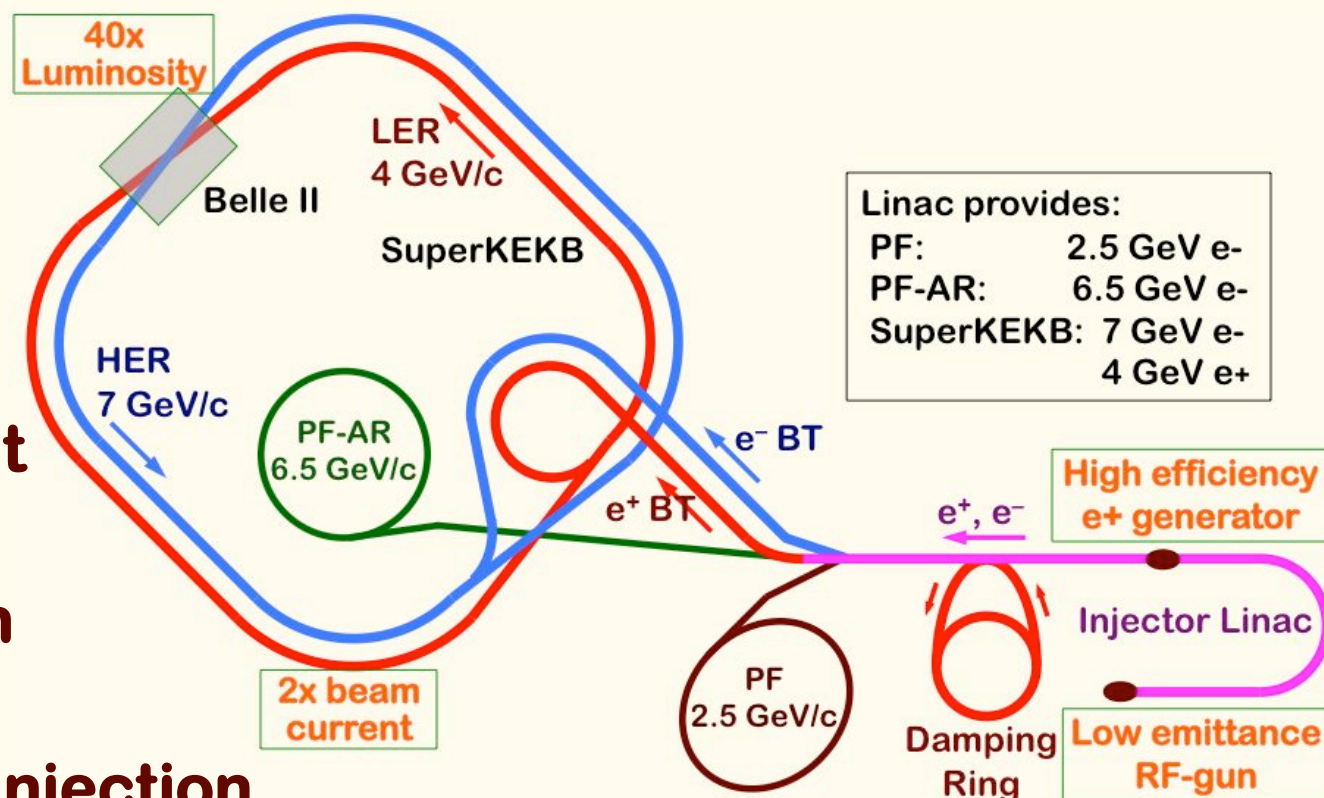



電子ビームパラメータ

	SuperKEKB	KEKB
エネルギー (GeV)	7.0	8.0
HER蓄積電流値 (A)	2.6	1.1
HERビーム寿命 (min.)	6	200
最大ビーム繰り返し (Hz)	50	50
最大バンチ数 (rfパルス当たり)	2	2
エミッタンス (mm·mrad)	50/20 (Hor./Ver.)	100
バンチ電荷量 (nC)	5	1
エネルギー広がり (%)	0.1	0.05
バンチ長 σ_z (mm)	1.3	1.3
ダンピングリング	n/a	n/a
同時トップアップ入射	4 rings (SuperKEKB e-/e+, PF, PF-AR)	3 rings (KEKB e-/e+, PF)



陽電子ビームパラメータ

	SuperKEKB	KEKB
エネルギー (GeV)	4	3.5
LER蓄積電流値 (A)	3.6	1.6
LERビーム寿命 (min.)	6	133
最大ビーム繰り返し (Hz)	50	50
最大バンチ数 (rfパルス当たり)	2	2
エミッタンス (mm·mrad)	100/20 (Hor./Ver.)	2100
バンチ電荷量 (nC)	4	1
エネルギー広がり (%)	0.1	0.125
バンチ長 σ_z (mm)	0.7	2.6
ダンピングリング	○	n/a
同時トップアップ入射	4 rings (SuperKEKB e-/e+, PF, PF-AR)	3 rings (KEKB e-/e+, PF)

Linac Upgrade Progress towards SuperKEKB (1)

◆ High-charge low-emittance RF gun development

- ❖ QTWSC cavity and Ir₅Ce photo cathode works well

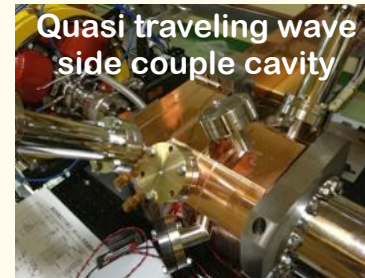

◆ Positron generation confirmation for the first time

- ❖ Good agreement with the simulation results

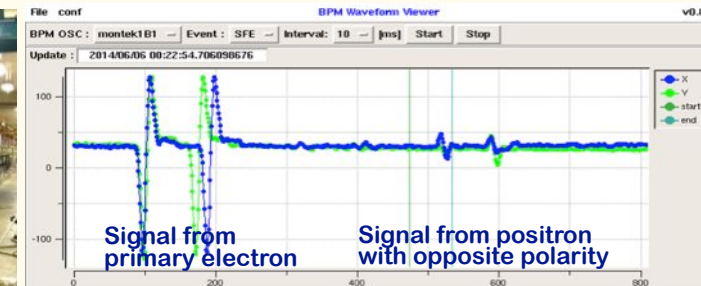
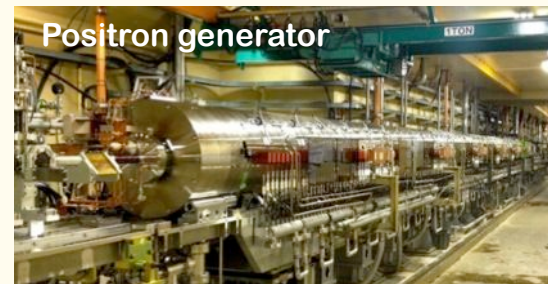

◆ Precise alignment for emittance preservation

- ❖ Recovering after earthquake
- ❖ Reaching specification of 0.3mm

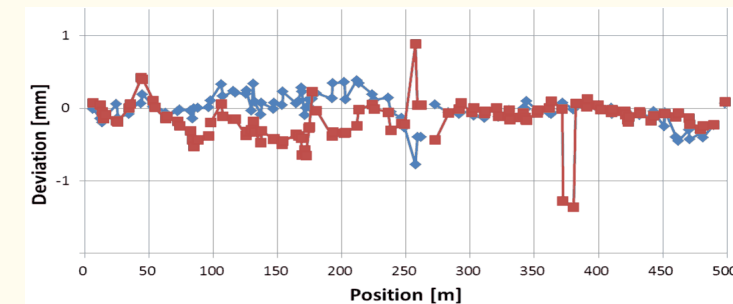

◆ Utility upgrade during summer 2014

- ❖ for electricity (+1.5MW) and cooling water (+1400L/min)

Linac Upgrade Progress towards SuperKEKB (2)

◆ High power modulator upgrades

◆ Low-level RF controls/monitor

- ❖ Pulse-to-pulse modulation (PPM) between 4+1 rings
- ❖ More spaces for increased number of devices

◆ Beam instrumentation

- ❖ Large/small aperture beam position monitors (BPM)
- ❖ Precise/fast and synchronized BPM readout system
- ❖ Wire scanners and beam loss monitors
- ❖ Streak cameras
- ❖ (Deflectors, etc)

◆ Event timing control system

- ❖ Combination of MRF and SINAP modules
- ❖ Essential for PPM operation
- ❖ Precise timing & synchronized controls
- ❖ Bucket selection at DR and MR

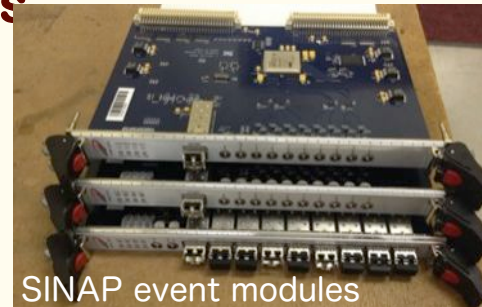

SINAP event modules

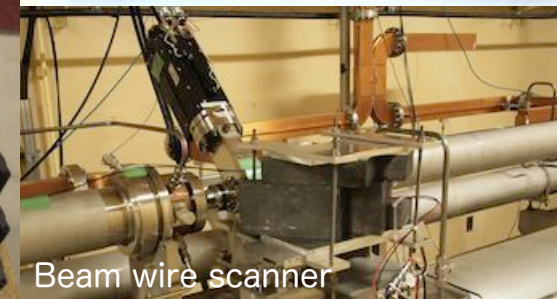

Beam wire scanner



Alignment



Alignment

- ◆ High-precision alignment was not necessary in PF and KEKB injections, and it was much damaged by earthquake in 2011.
- ◆ Instead of flexible-structure girder before earthquake, **rigid-structure** was adopted with jack-volts and fixed supports.
- ◆ **Reflector pedestals** are developed and mounted onto quad magnets and accelerating cavities for laser-tracker measurement.
- ◆ Iterative measurement and adjustment with 500-m straight laser and position sensors should enable **0.3-mm global alignment**.
- ◆ Laser tracker should enable **0.1-mm** measurement within 10-m girder unit.
- ◆ Displacement gauges, hydrostatic leveling, inclinometer are also employed.
- ◆ Remote measurement system and **girder mover** system will be necessary for longer term, and are under development.

Emittance Preservation and Alignment

- ◆ **If Device is off center of the beam**
 - ❖ Focusing magnet (quad) kicks the beam bunch
 - ❖ Accelerating structure (cavity) excites wakefield, to bend the tail
- ◆ **Distorted bunch in banana shape**
 - ❖ Emittance dilution or blow-up, even 100 times larger
 - ✧ Depending on the beam optics and the beam charge
- ◆ **Alignment and orbit correction is crucial to preserve the emittance**

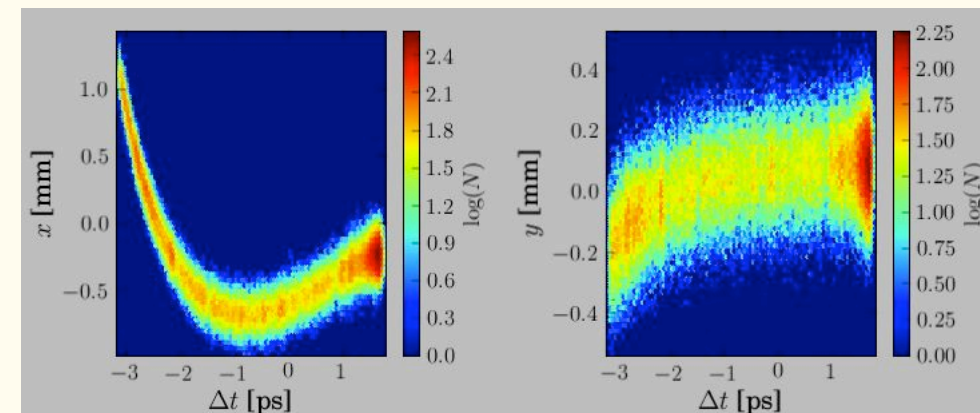
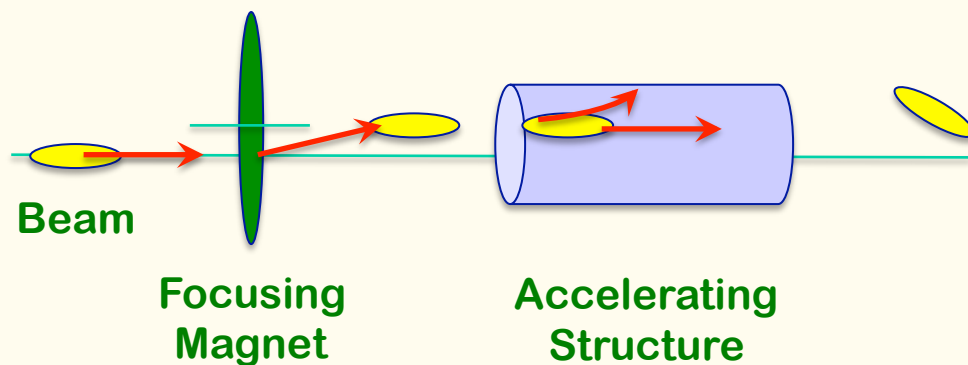

Transverse beam distribution in time direction

Emittance Preservation

- ◆ Offset injection may solve the issue
- ◆ Orbit have to be maintained precisely
- ◆ Mis-alignment should be $<0.1\text{mm}$ locally, $<0.3\text{mm}$ globally

Mis-alignment leads to Emittance blow-up

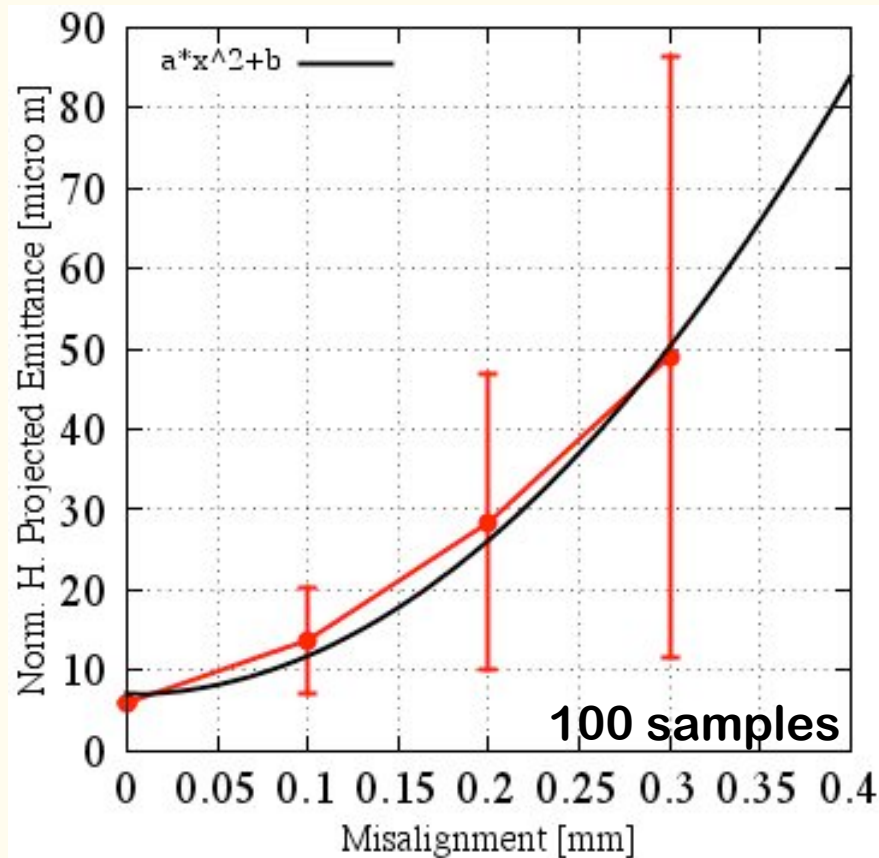

Orbit manipulation compensates it

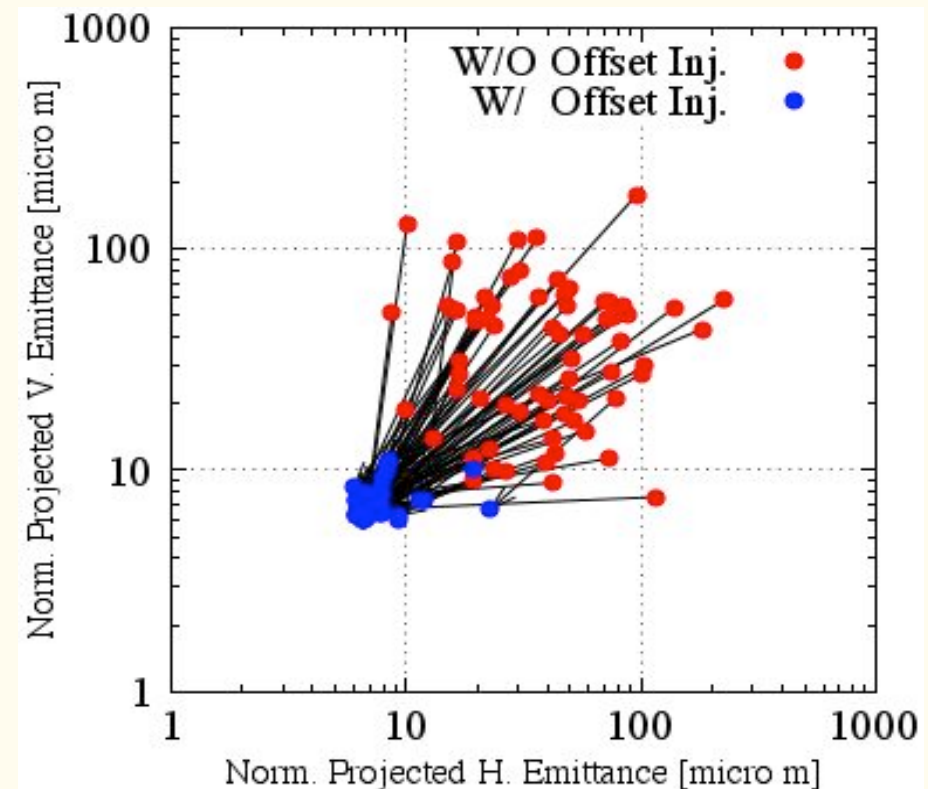

Sugimoto et al.

Alignment progress in 2014

Higo et al.

- ◆ For the first time after earthquake at downstream sectors
- ◆ Several measurements during summer
- ◆ Measurement reproducibility was confirmed up to ~ 0.2 mm
- ◆ While there existed several conflicting measurements, consistent scheme has been established
- ◆ Movement of tunnel by several 10's of micrometer was observed (\rightarrow mover)
- ◆ Further work necessary in 2015, for alignment and girder replacement

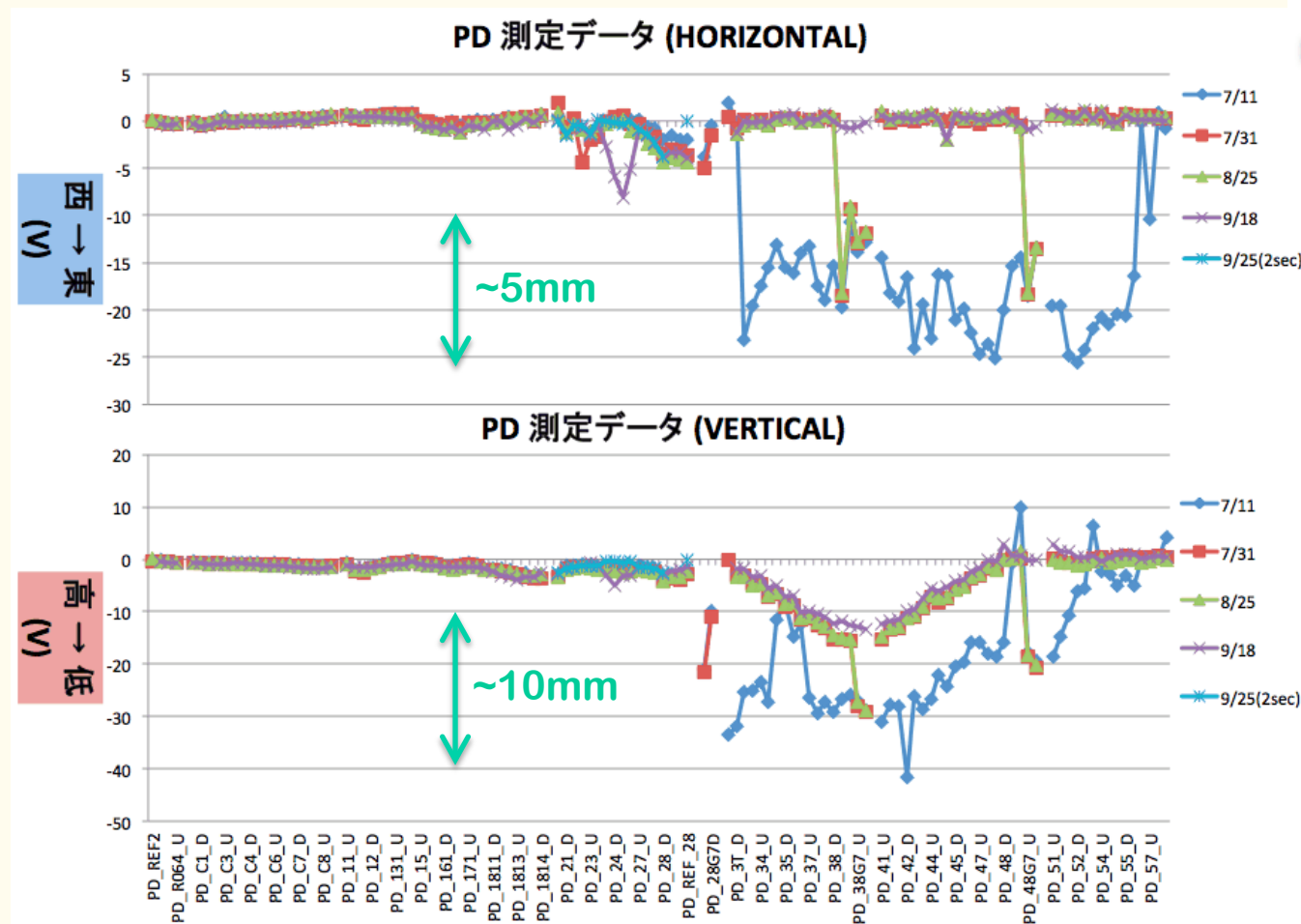



Recent 500-m alignment over C-5

after completion of initial alignment in late Jan. 2015

Higo et al.

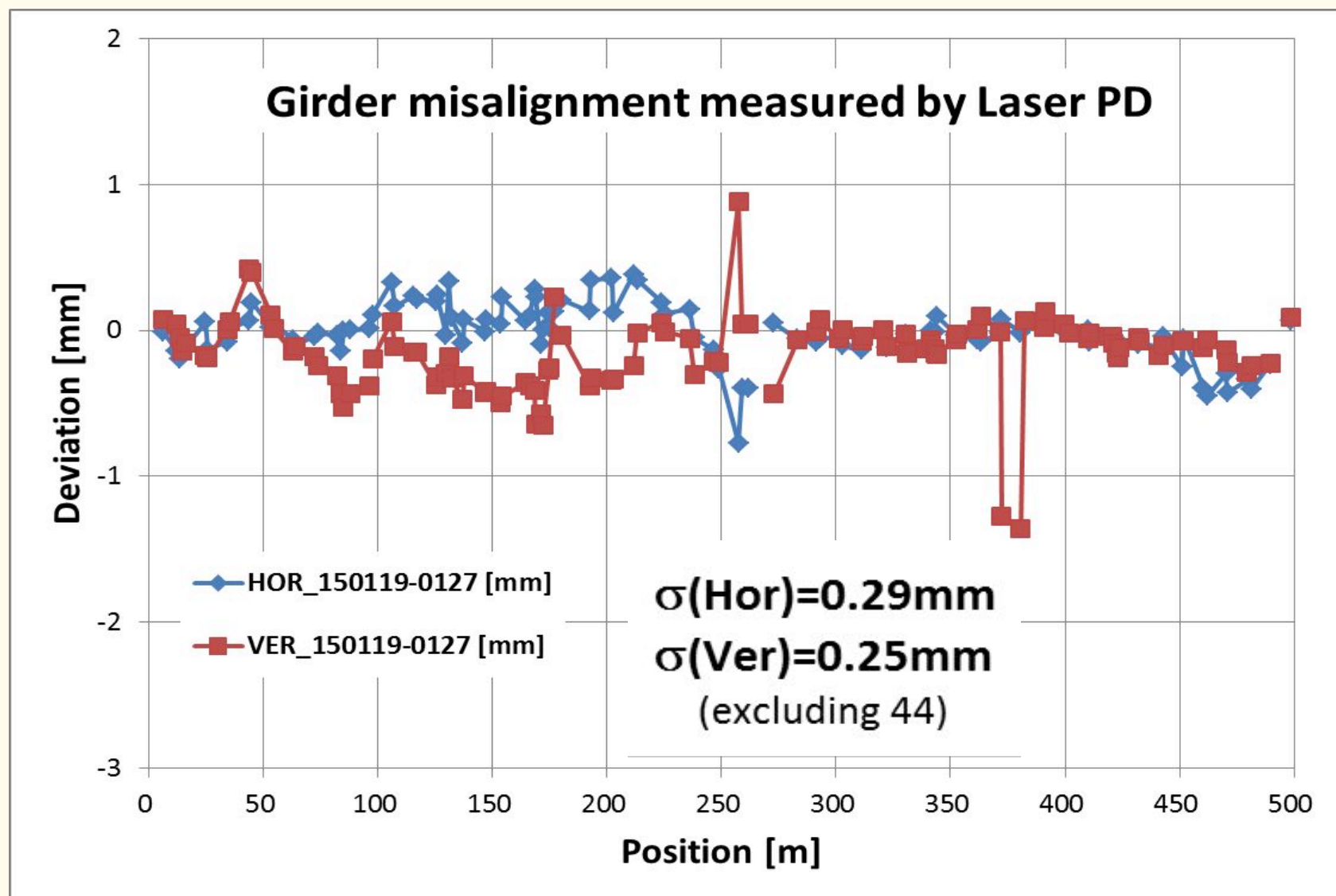

Hardware alignment on girders in sectors 3~5

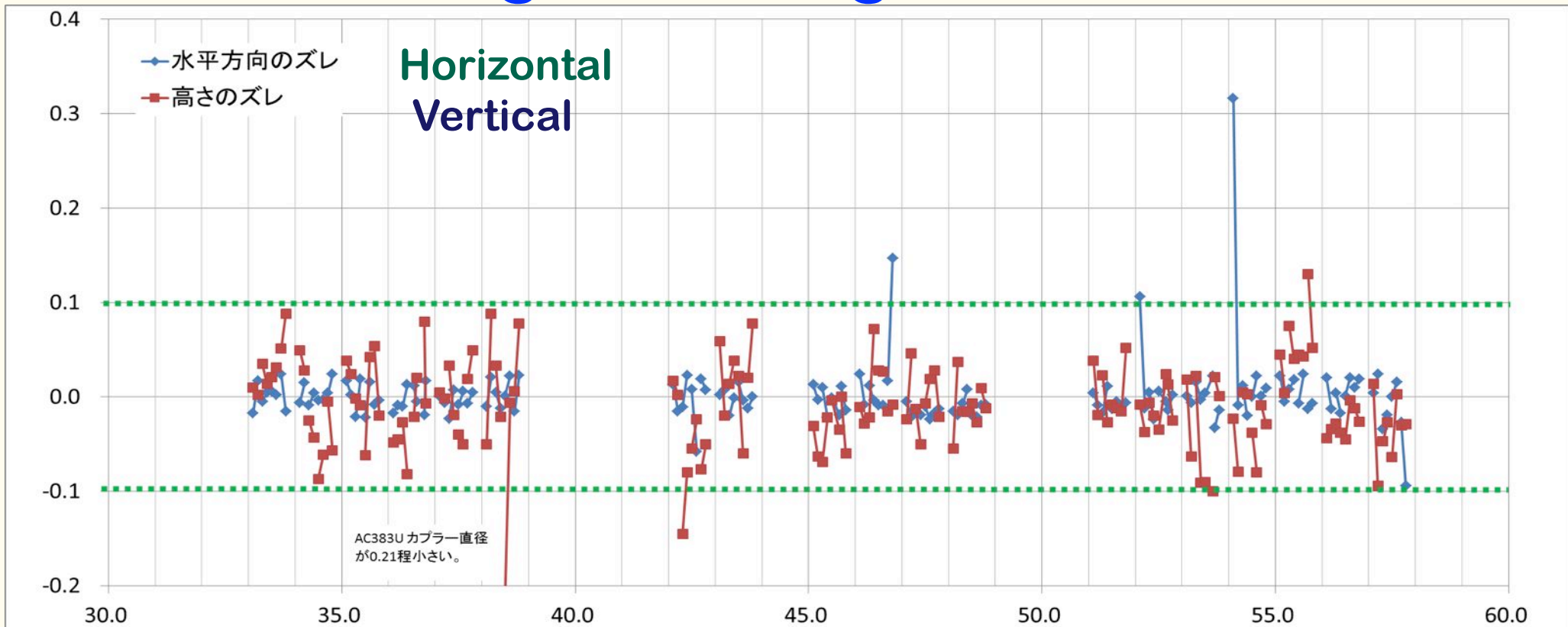

■ 水平方向のズレ

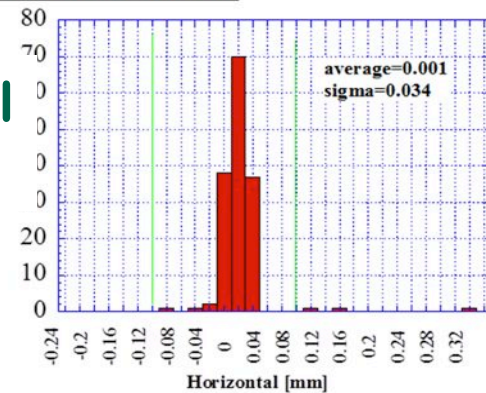

Horizontal
 $\sigma=34\mu\text{m}$

■ 高さのズレ

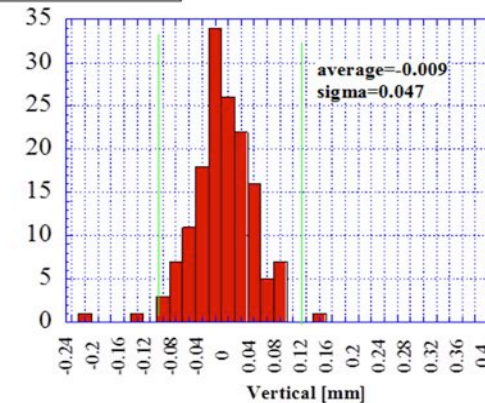

Vertical
 $\sigma=47\mu\text{m}$

Higo et al.



Floor vertical movement

in a half year from summer to winter

Higo et al.

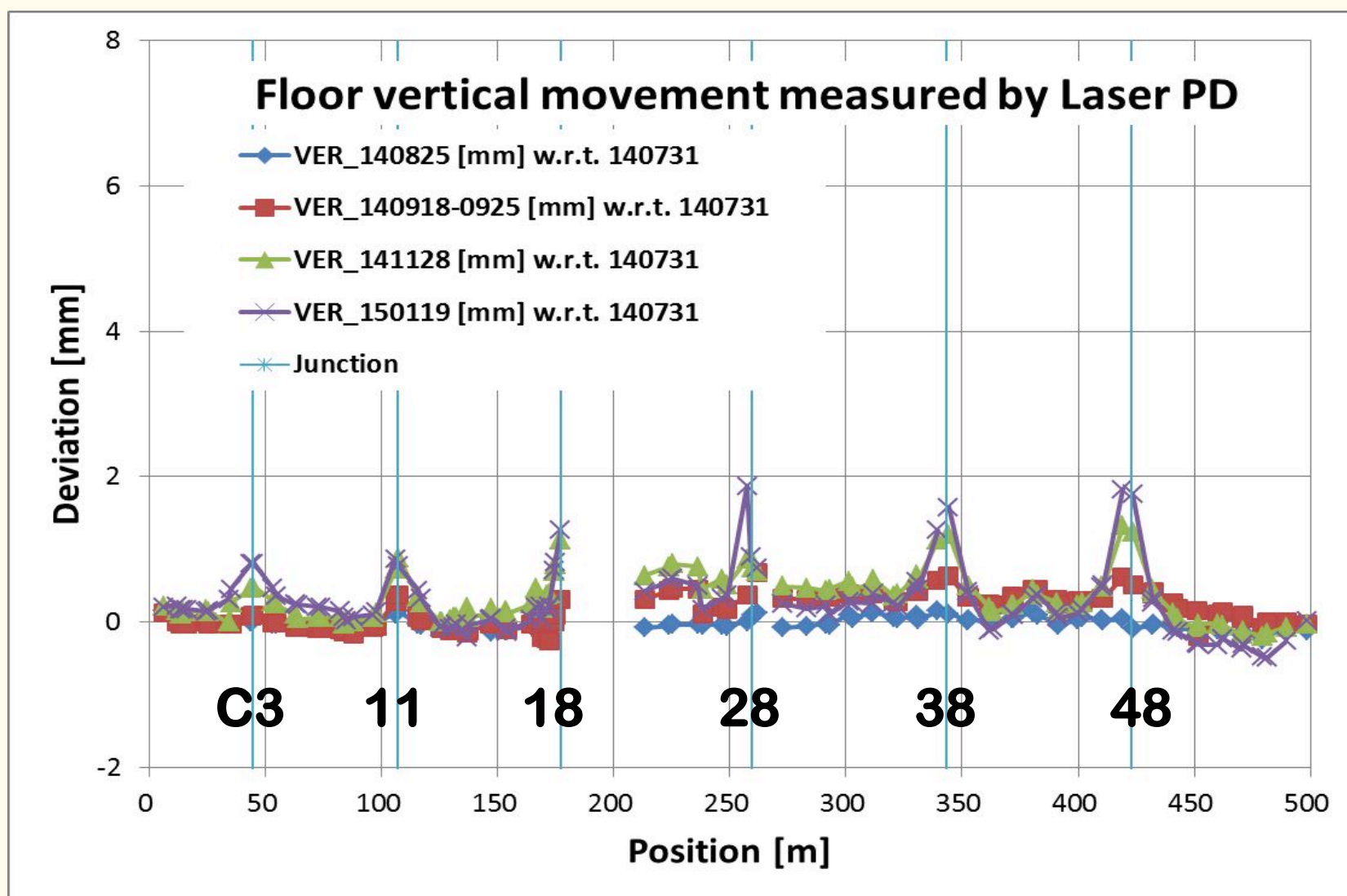



Estimation of floor movement

some typical observed values

	Horizontal	Vertical
Daily	0.1	0.1
Week	0.1	0.1
Half a year	0.5	2
Speed	0.01mm/hour	0.01mm/hour

Unit mm

We should study/develop the linac system with these values in mind.

Precise beam orbit control is necessary to preserve emittance



RF gun



RF-Gun development strategy for SuperKEKB

◆ Cavity : Strong electric field focusing structure

❖ Disk And Washer (DAW) ⇒ 3-2, A-1(test)

❖ Quasi Traveling Wave Side Couple ⇒ A-1

⇒ Reduce beam divergence and projected emittance dilution

◆ Cathode : Long term stable cathode

❖ Middle QE (QE= $10^{-4} \sim 10^{-3}$ @266nm)

❖ Solid material (no thin film) ⇒ Metal composite cathode

⇒ Started from LaB₆ (short life time)

⇒ Ir₅Ce has very long life time and QE > 10^{-4} @266nm

◆ Laser : Stable laser with temporal manipulation

❖ LD pumped laser medium ⇒ Nd / Yb doped

❖ Temporal manipulation ⇒ Yb doped

⇒ Minimum energy spread



Photo cathode RF gun development

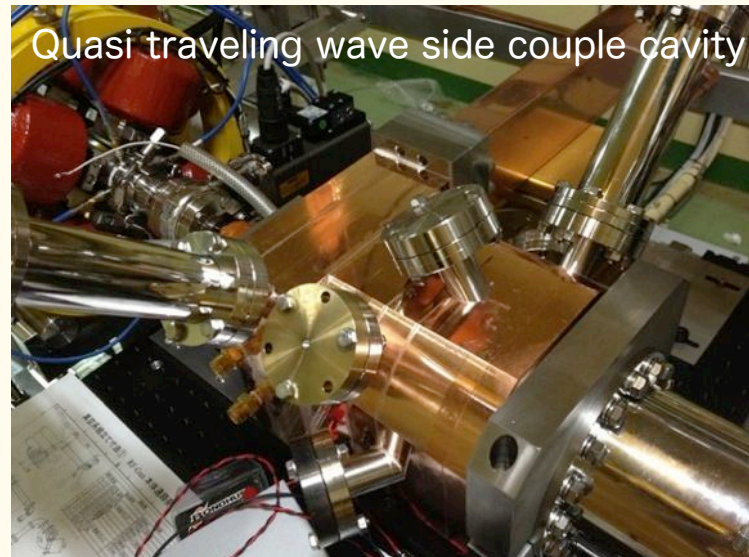
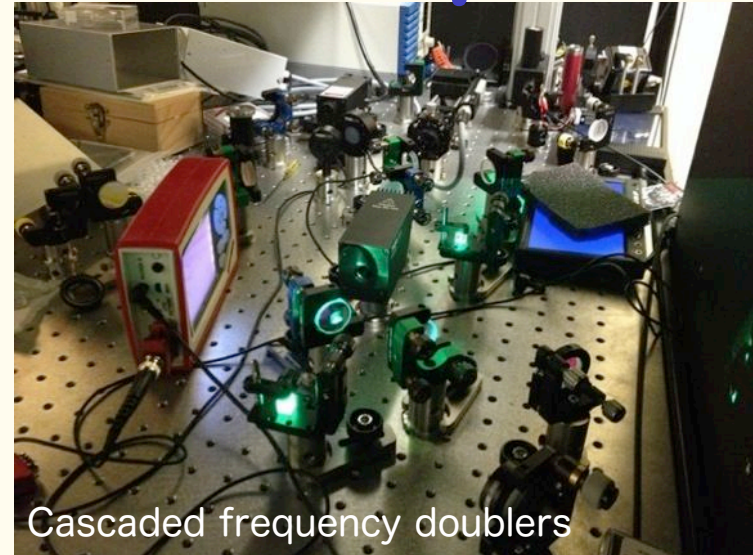
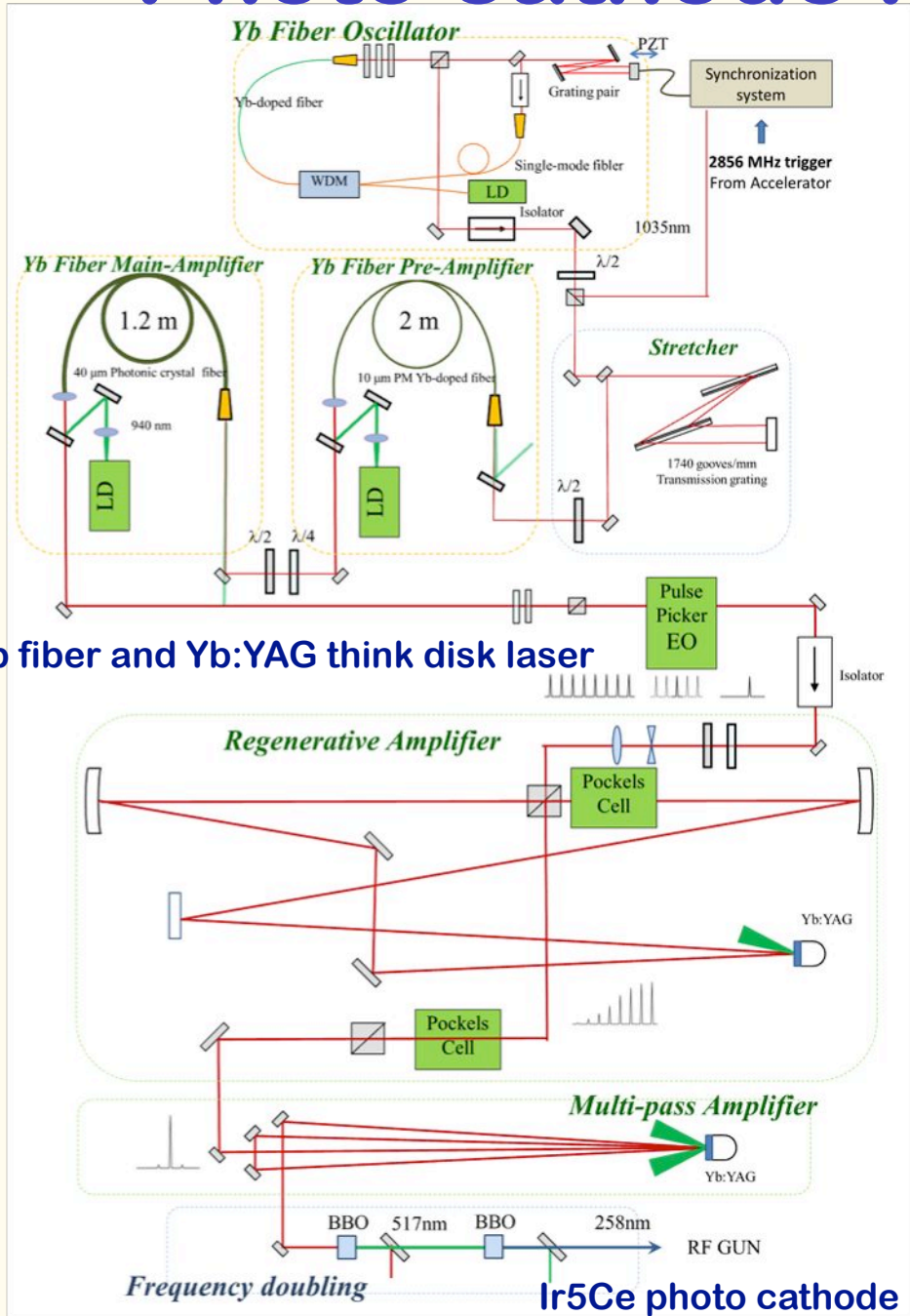

- ◆ 5.6 nC / bunch was confirmed
- ◆ Next step: 50-Hz beam generation & Radiation control

Beam line will be upgrade on up and down.

Yoshida et al.

Thermionic DC gun will be installed to upper beam line.

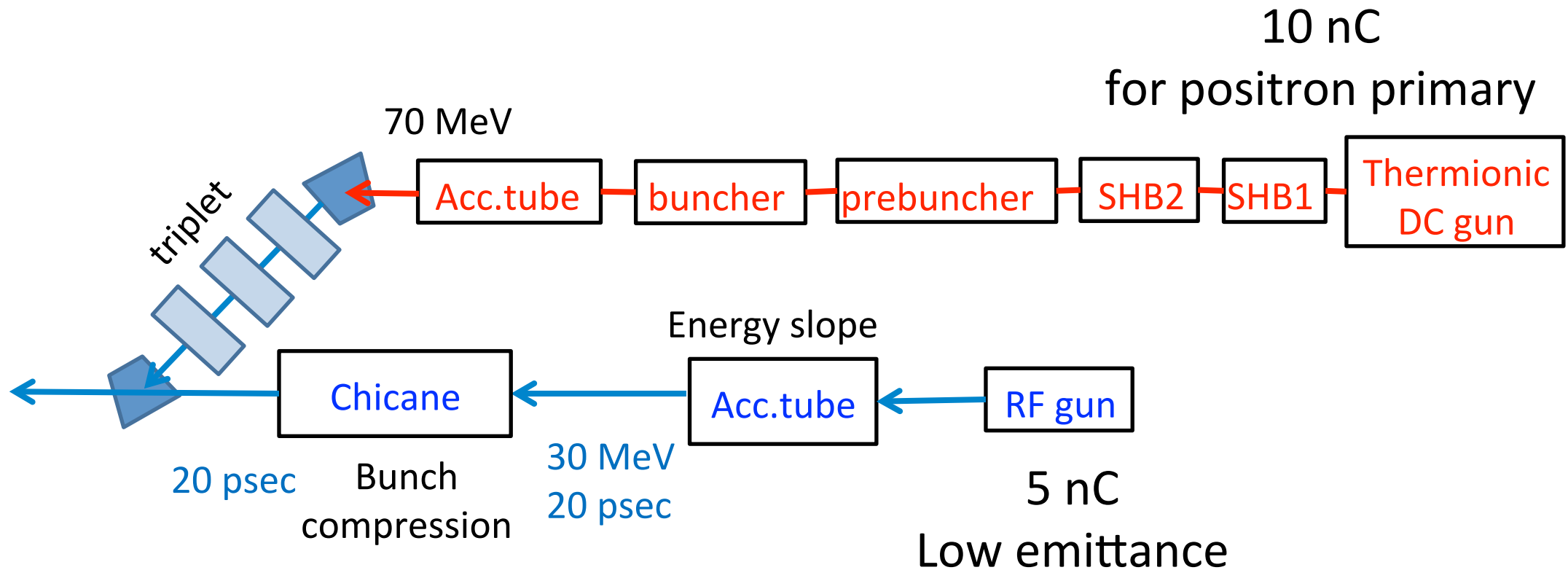

Second Side coupled Quasi-travelling wave RF-Gun

Second RF-Gun under brazing

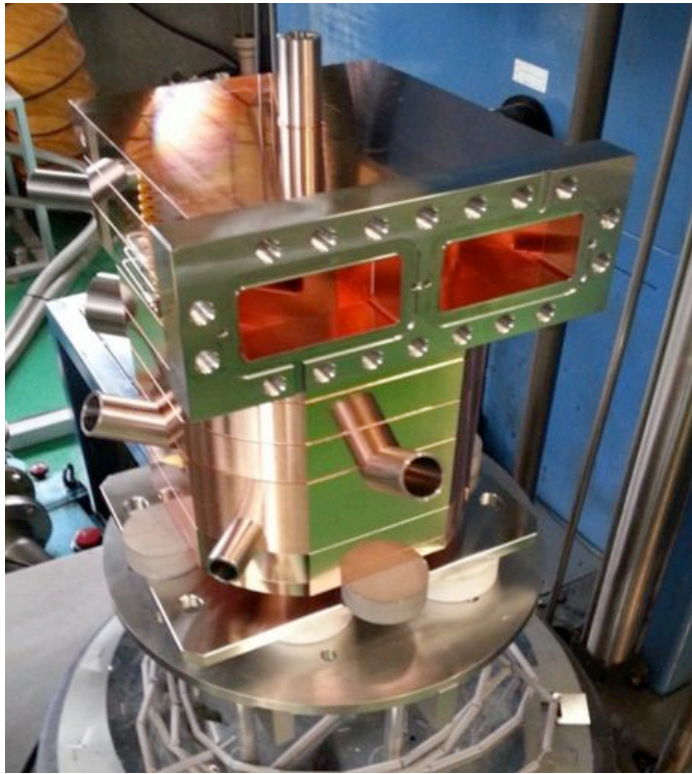

Conditioning progress was too slow.

Frequent break down is the issue to be cured.

Cathode rod contact?

Cathode material fixation?

Cathode material sputtering due to laser?

We have to analyze break-down issues.

1. Cavity conditioning, used dummy cathode rod without cathode material (all Cu).
2. Replace new cathode rod with material (new fixation is shrinkage fit).
3. For reduce multipactoring effect, another cathode cell design is required.

Present cathode

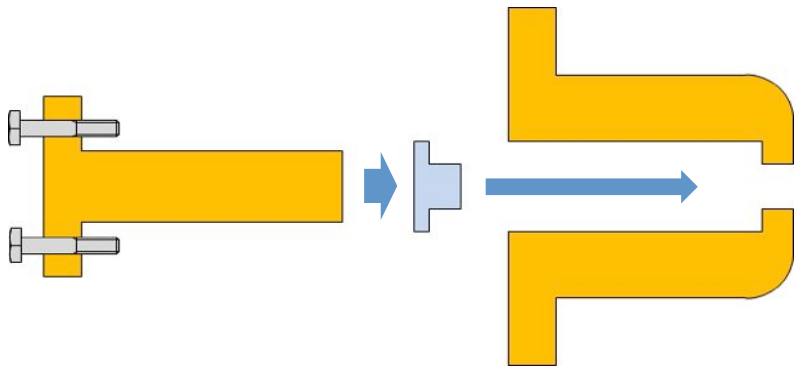

New cathode

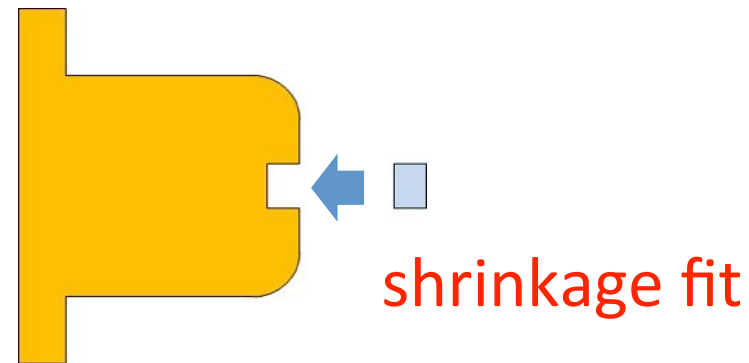

Short term plan for laser development

- Following recommendations at review meetings
- Underground Yb-Fiber + Yb:YAG (Existing)
 - Downgrade to 25Hz 2-loop amplifier(Done) => Fix configuration
 - Increase monitor points / quadrant detector etc..
 - Improve stability.
- Underground Yb-Fiber + Nd:YAG (Yb-Fiber small upgrade)
 - 1064nm(Nd:YAG wavelength) is converted by existing Yb oscillator.
 - Stretcher for 10 ps is similar to existing one.
 - Existing fiber amplifier (Thorlabs) is best fit to amplify 1064nm.
 - Preliminary test using existing Nd:YAG DPSS Module (10Hz).
- Ground Yb-Fiber(Commercial) + Cryogenic Yb:YAG
 - => Postponed the operation until Phase-III.
- Ground Yb-Fiber(Commercial) + Nd:YAG(Commercial)
 - MENLO Orange oscillator wavelength must be shifted.
or use Nd:YLF (1047nm).
 - Yb-Fiber commercial amplifier can be used for 1064nm.
 - Nd:YAG 50Hz DPSS commercial module
 - Vacuum duct / Room environment / Virtual cathode.

New high gain multi-pass amplifier(10-15 pass x 2 loop) to simplify the laser

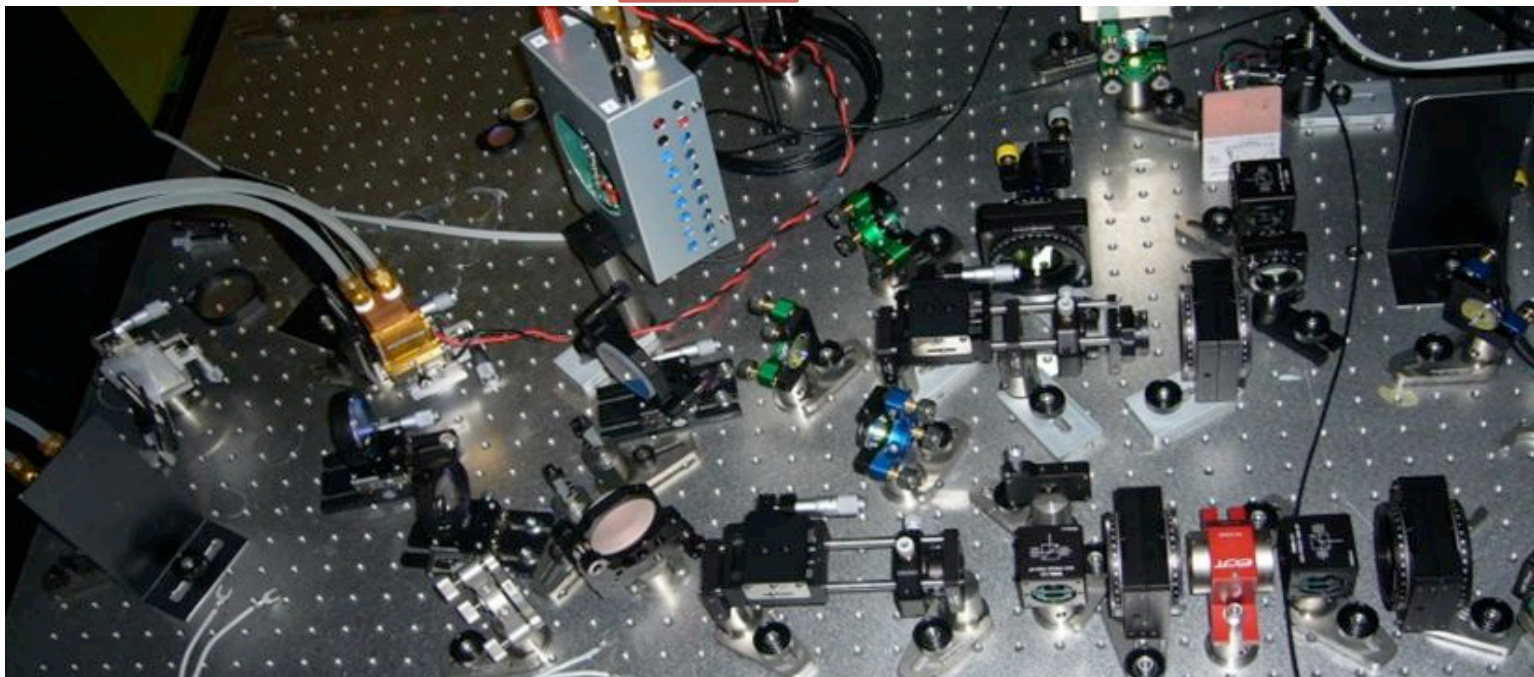
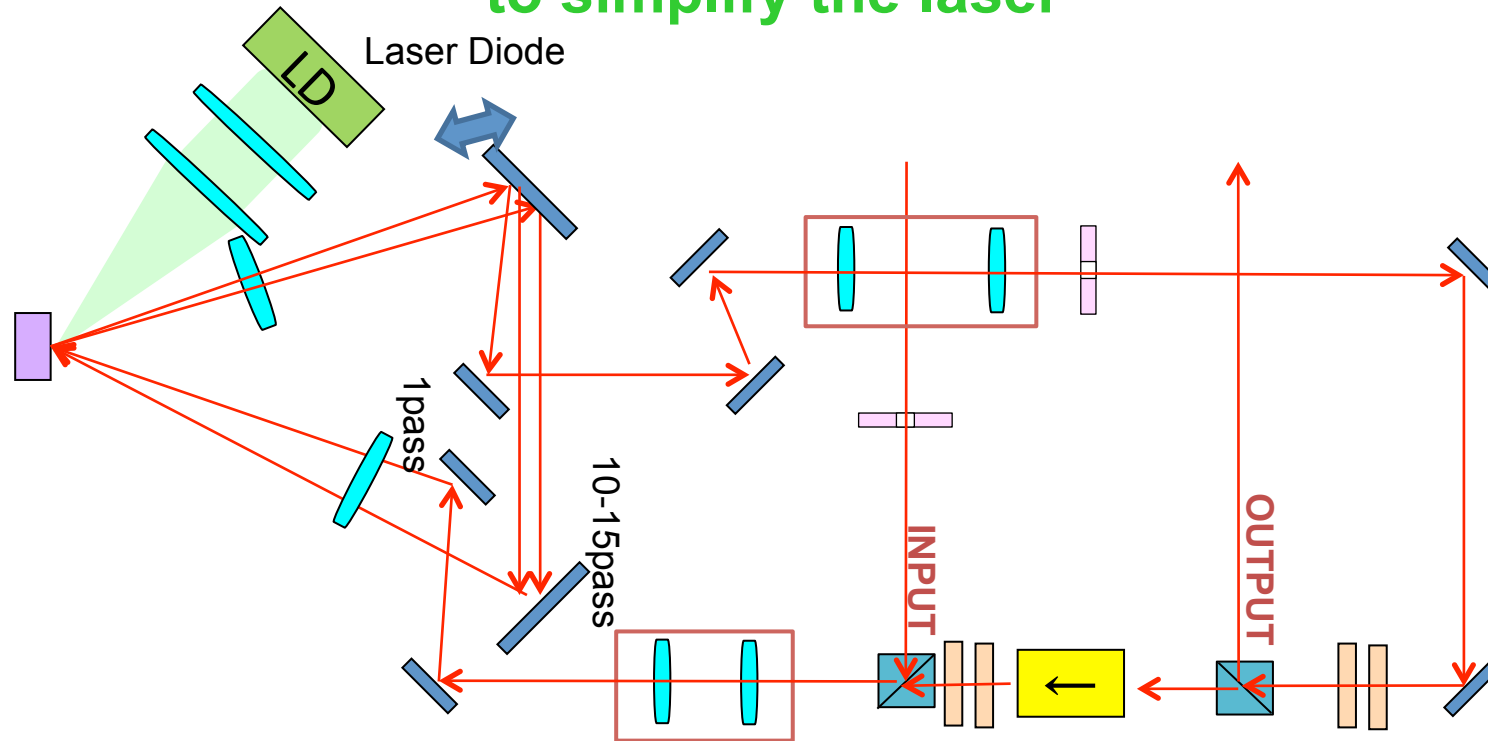

Simplify and stabilize our laser system without pulse shaping

Existing laser system

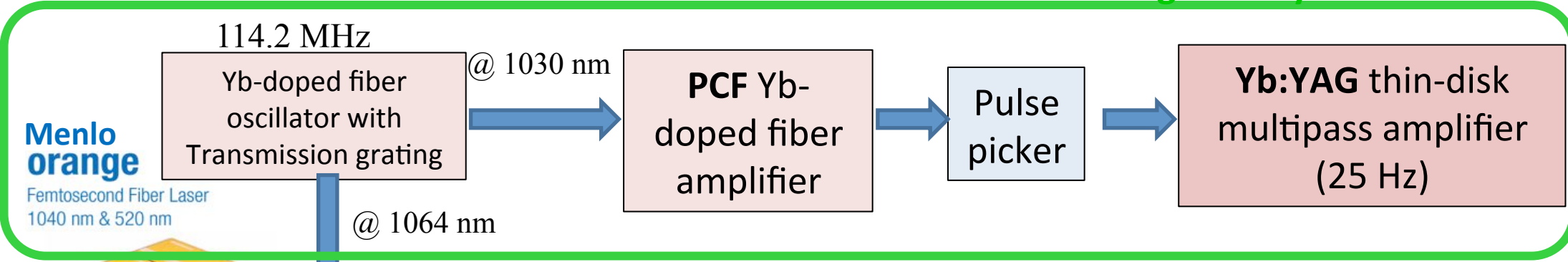

Simple Nd amplifier laser system without pulse shaping according to RF-Gun reviewer's comment

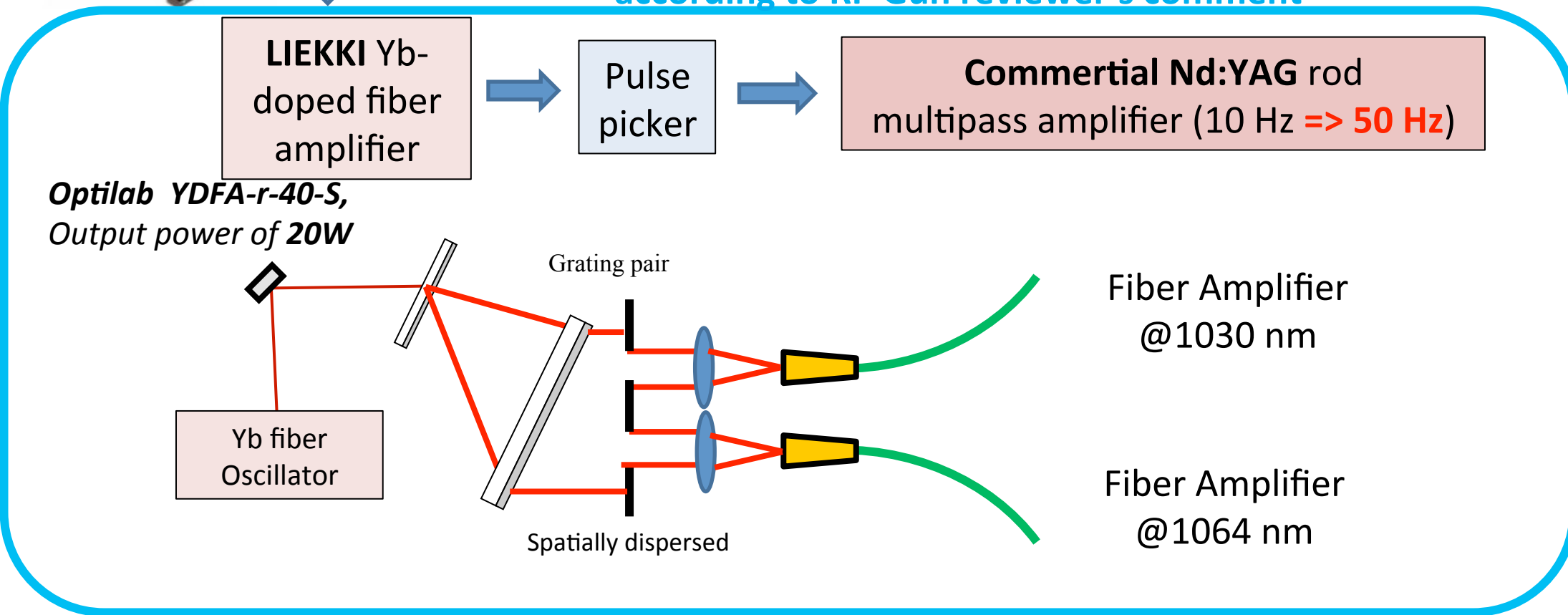

Strecher for Yb:YAG & Nd:YAG

	Yb:YAG	Nd:YAG
Center wavelength	1030 nm	1064 nm
Gain spectrum width	~2 nm	~0.5nm
Distance of the Stretcher to 30 ps	1.5 m	6 m (×4)

Gain spectrum of Yb:YAG

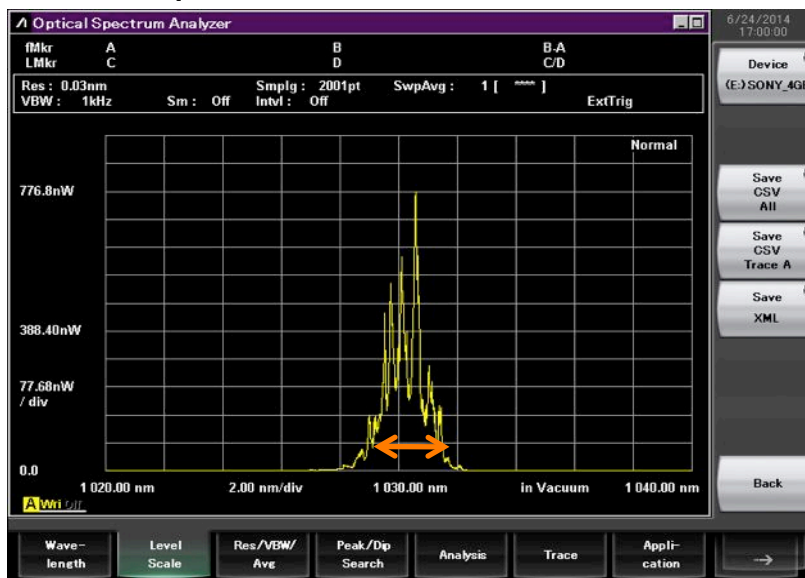

2.0nm

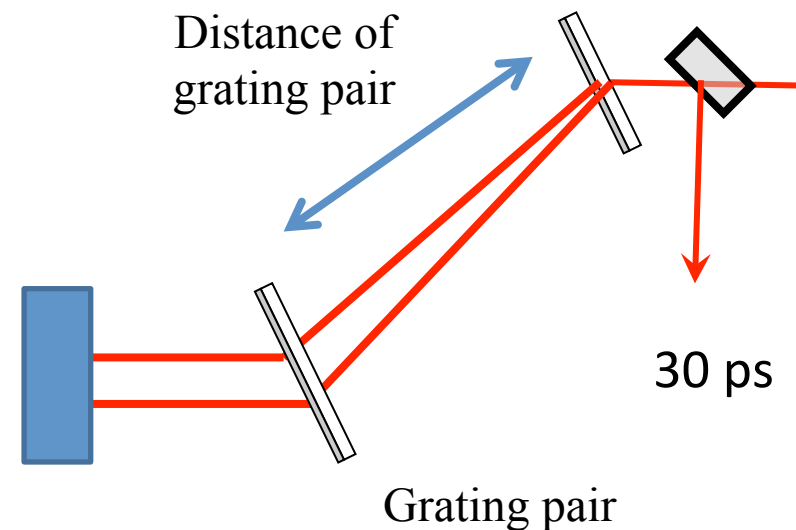

Nd:YAG DPSS module regenerative amplifier (experimental)

Regenerative amplifier

Oscillator

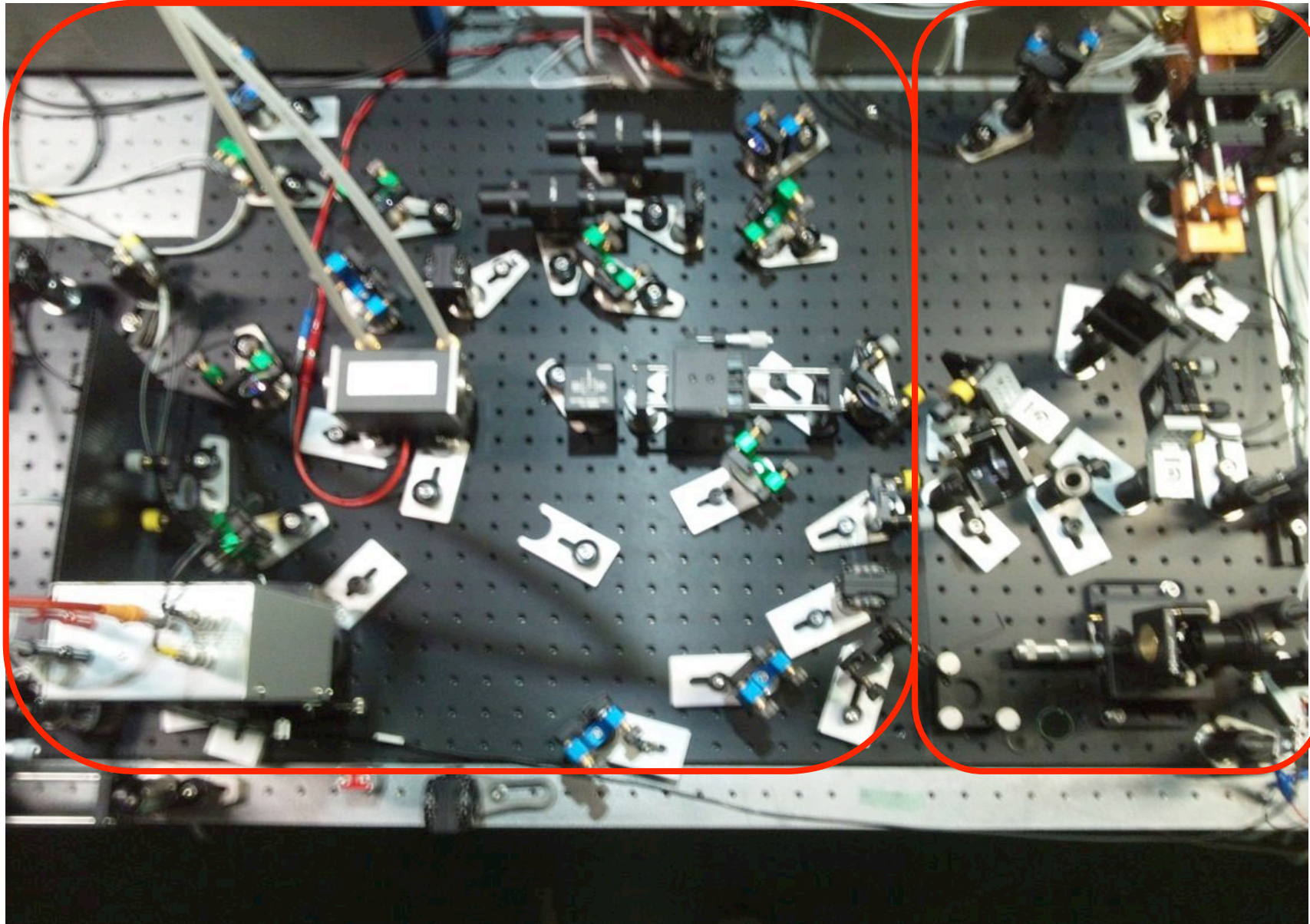

Test at A-1 underground using existing Yb-Fiber oscillator.



Thermionic gun

Preparation of Thermionic Gun

◆ Under refurbishment

❖ Raise by 75cm not to conflict with straight RF-gun

✧ As well as angled RF-gun

❖ ~ Jun.2015.

◆ May serve primary electron for positron generation

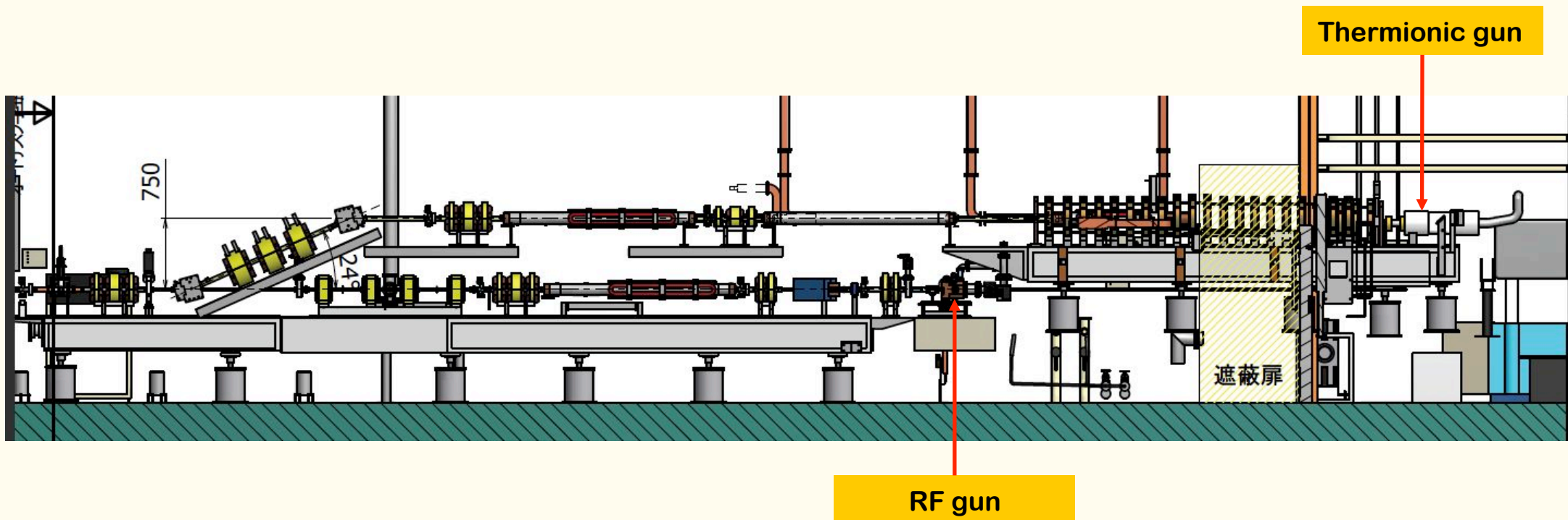

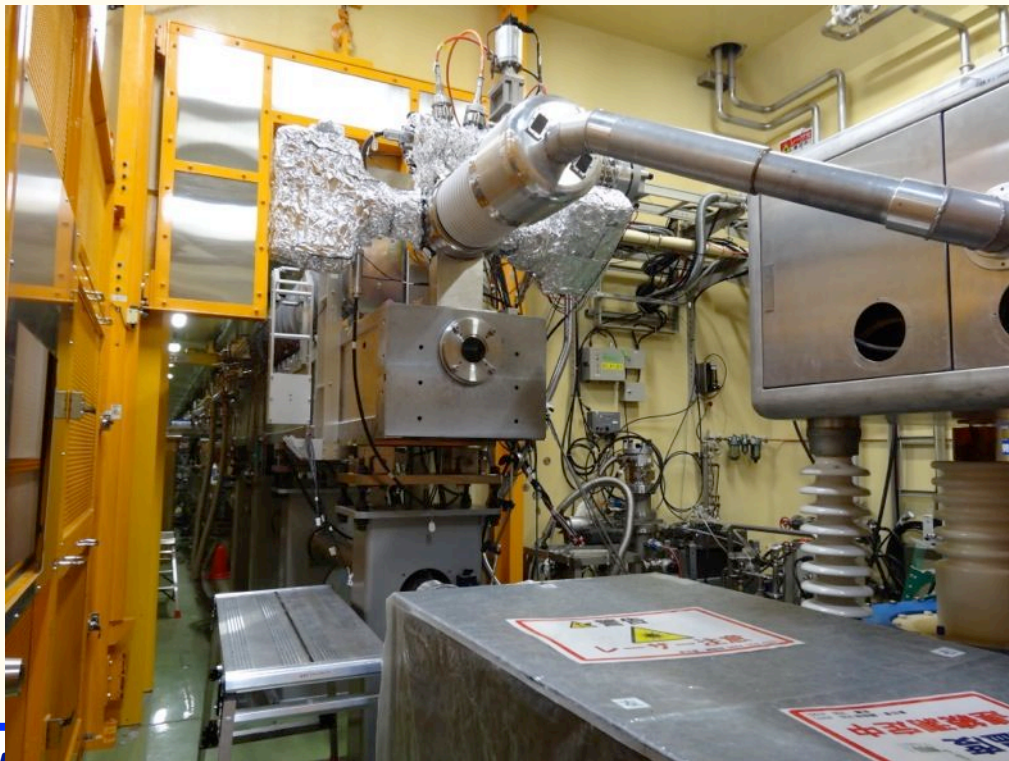
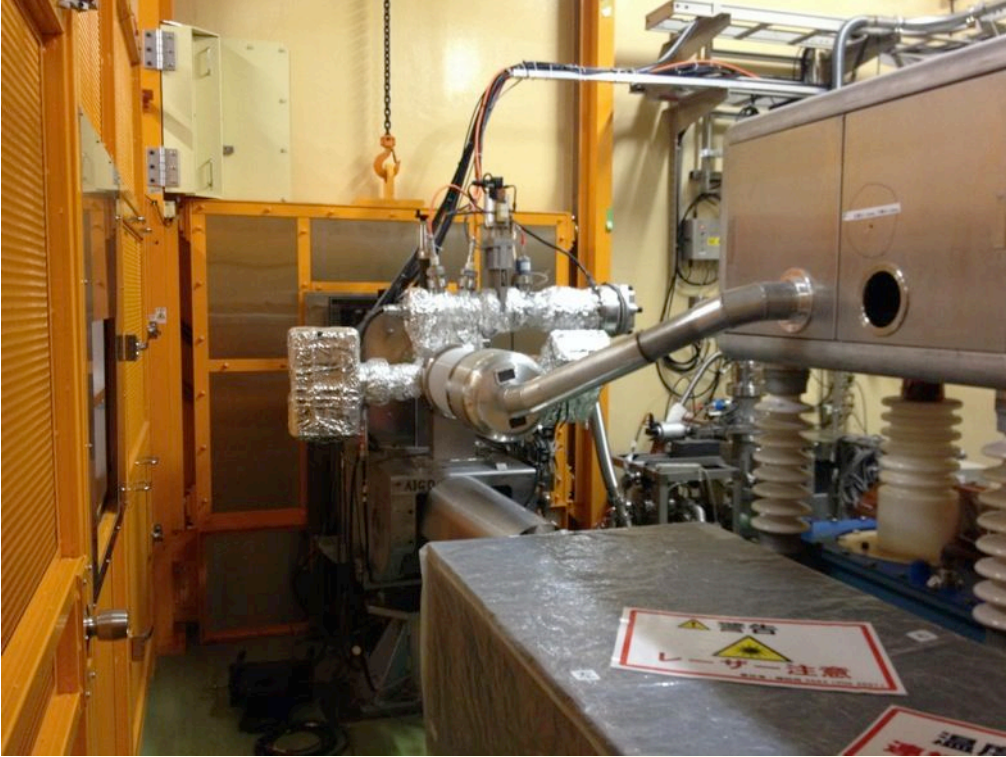

Linac upgrade / Progress towards SuperKEKB

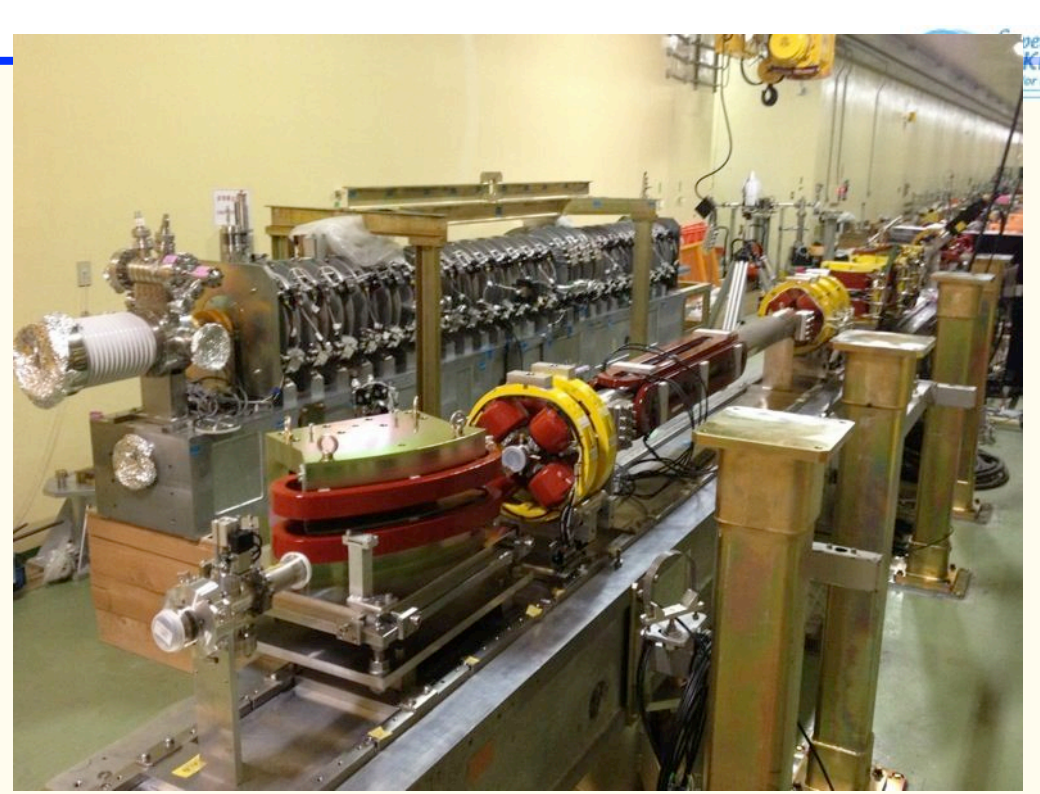

Linac Upgrade Progress towards SuperKEKB

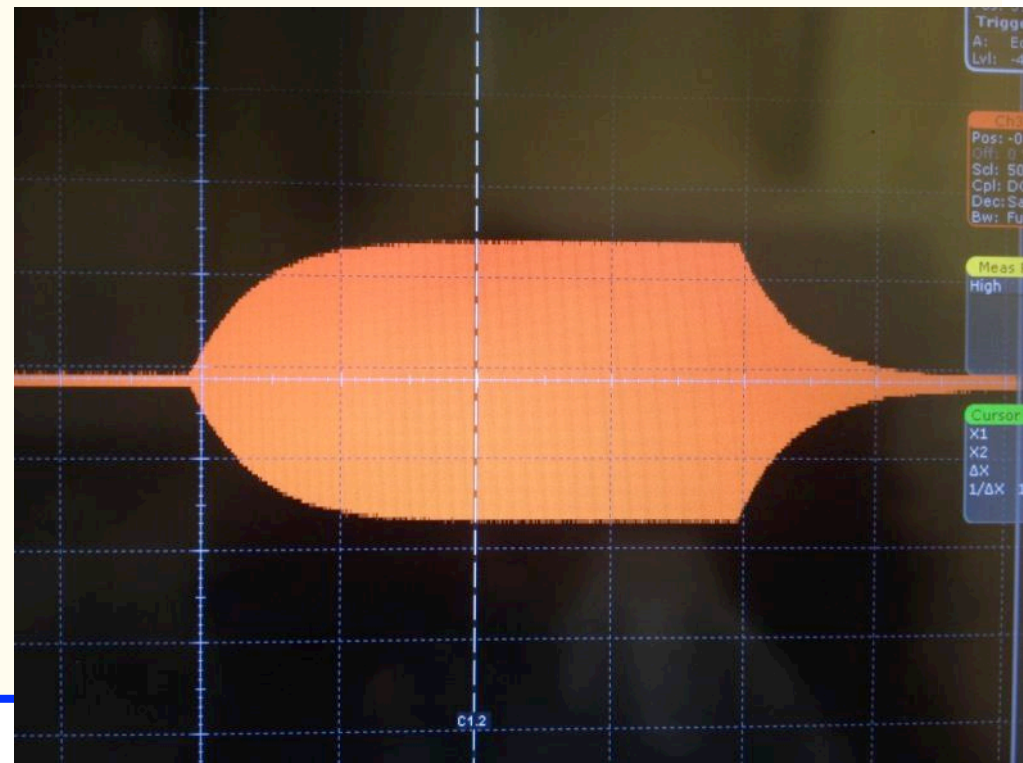

Linac Upgrade Progress towards SuperKEKB



Positron generator

Positron Generation

◆ 4-times more positron is required at SuperKEKB than KEKB

- ❖ Safety measure was taken after cable fire during the test of Flux Concentrator (FC)
- ❖ New components in 100-m capture section were tested in steps
- ❖ High voltage tests in tunnel in April
- ❖ Beam tests with electron in May



Positron from New Positron Capture Section

- ◆ Generated positron ~ 0.1 nC was transferred to the entrance of damping ring
- ◆ With higher magnetic and electric field, 4-nC positron will be generated
- ◆ Target shield (40cm x 6m long) will be finalized
- ◆ Alignment will be improved
3mm \rightarrow 0.1mm

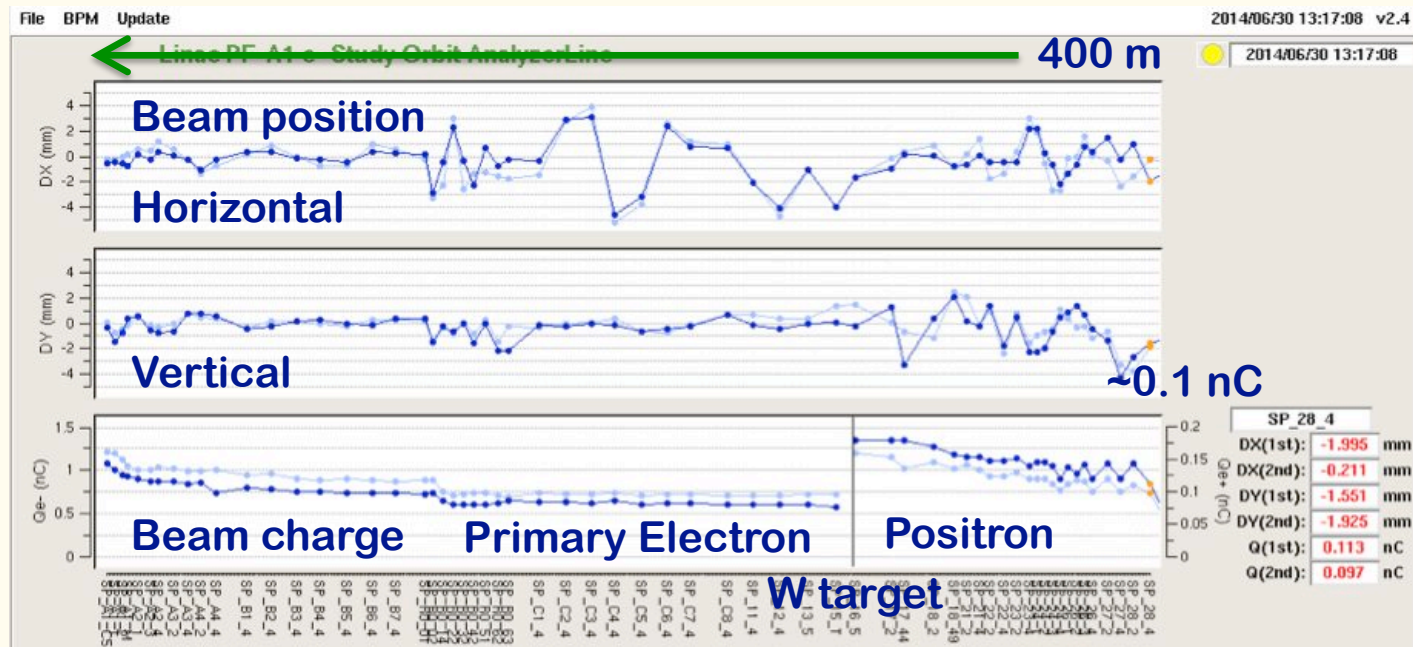
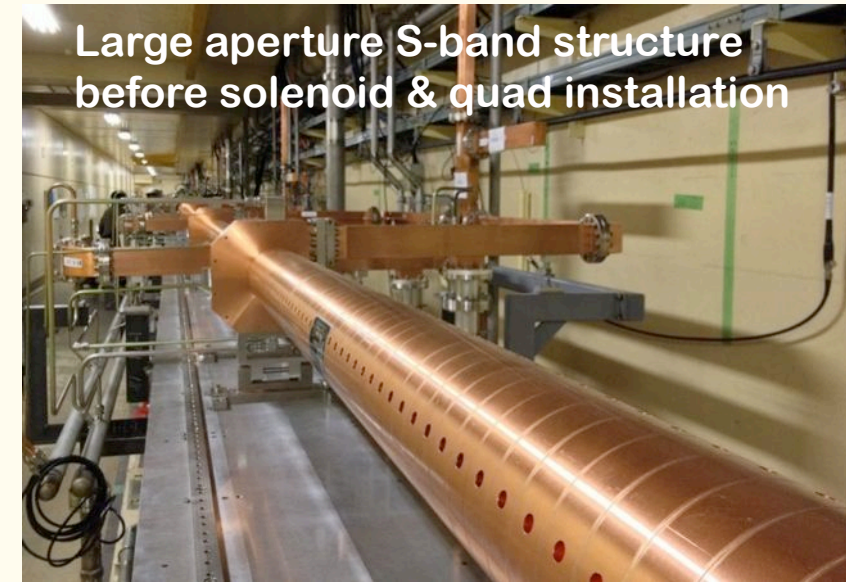

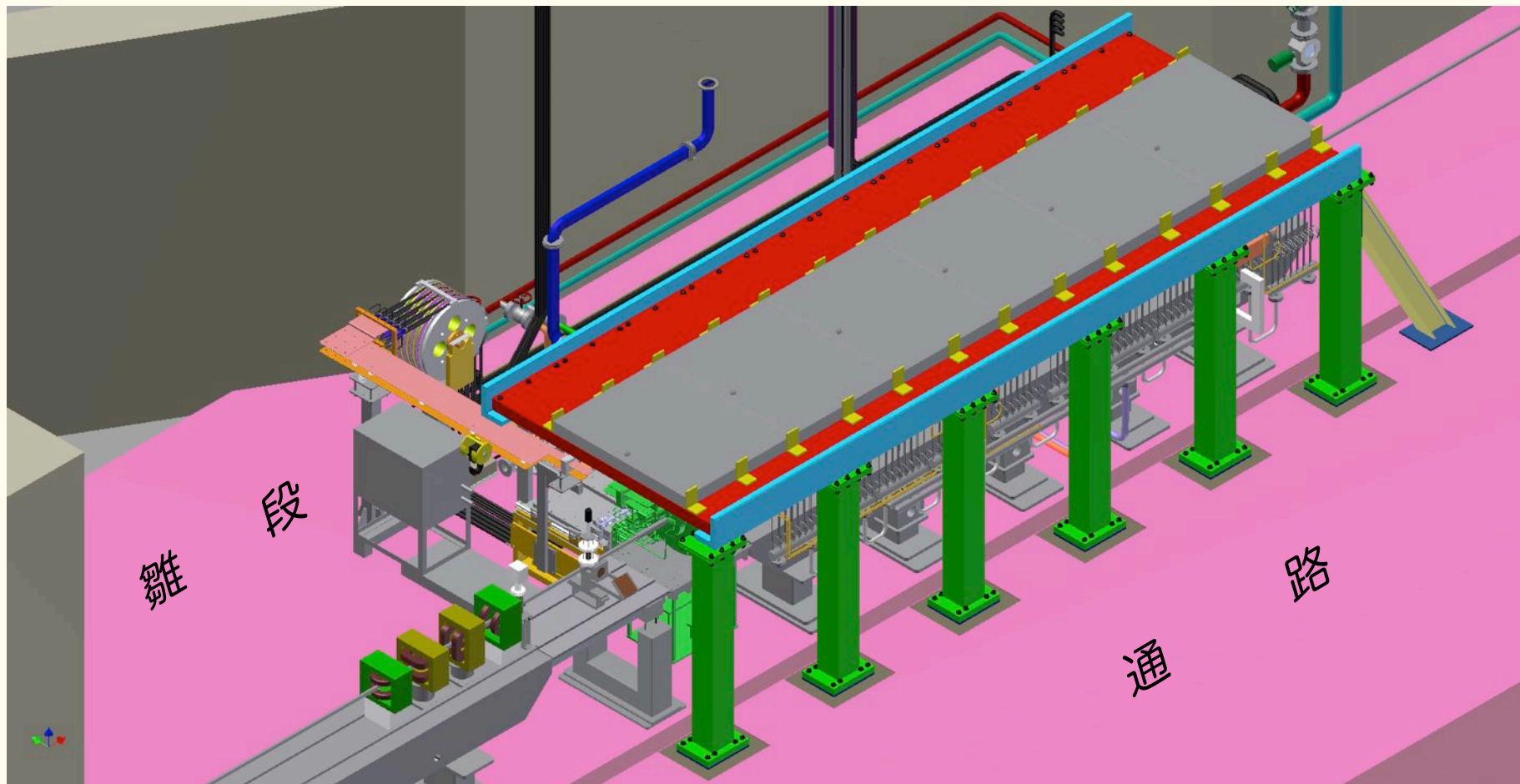

鳥瞰図：南東方向から見た図。 トンネル1-5 陽電子ターゲットの60cm上流から6mの範囲に設置。3月時の遮蔽鉄の厚みは200mm（図中の赤+灰色部）。200mm角柱 6本が現場通路上ビームラインよりに設置される。鉛カーテンを設置すると、通路の幅が現場では1400mm。申請電流値に合わせて鉄の厚さを追加する予定。

Radiation Shield Construction

#15 region





Positron Generation

- 1) Installation of positron generator for SuperKEKB in April 2014
(Beamline construction since summer 2013)
(positron target, spoiler, Flux Concentrator, bridge coils, LAS structures [x6], DC solenoids [16+13], e+/e- separator, quads [>90])
- 2) Commissioning of positron beam, observation of the first positron after reconstruction for SuperKEKB, further improvements expected

	Primary e- [nC]	Positron [nC]	Efficiency	Parameters
June 2014	0.6	0.12	20%	FC 6.4kA, Solenoids 370A, LAS capture field 10 MV/m
Specification (at SY2)	10.0	5.0	50%	FC 12kA, Solenoids 650A, LAS capture field 14 MV/m
DR injection (2017?)		4.0	40%	Energy spread acceptance 0.5%

- 3) Oct.~Dec.2014 : Linac commissioning
Jan.~Mar.2015 : Construction
Apr.2015~ : Linac commissioning
Feb.2016 : LER injection



Schedule



Linac Schedule Overview

RF-Gun e- beam commissioning at A,B-sector

e- commiss. at A,B,J,C,1

e+ commiss. at 1,2 sector (FC, DCS, Qe- 50%)
e- commiss. at 1,2,3,4,5 sector

Phase1: high emittance beam for vacuum scrub
Phase2,3: low emittance beam for collision

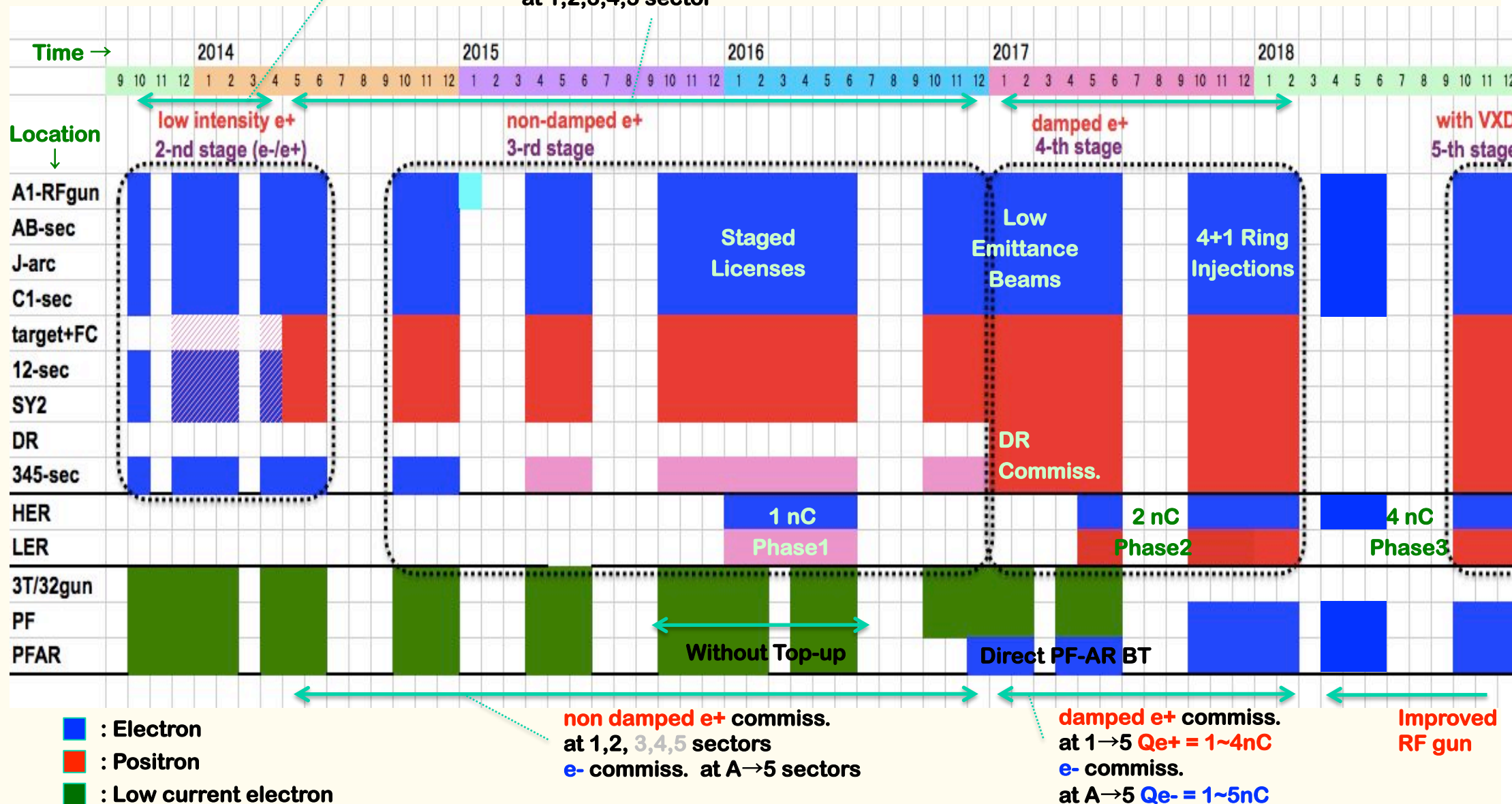

Injector linac schedule

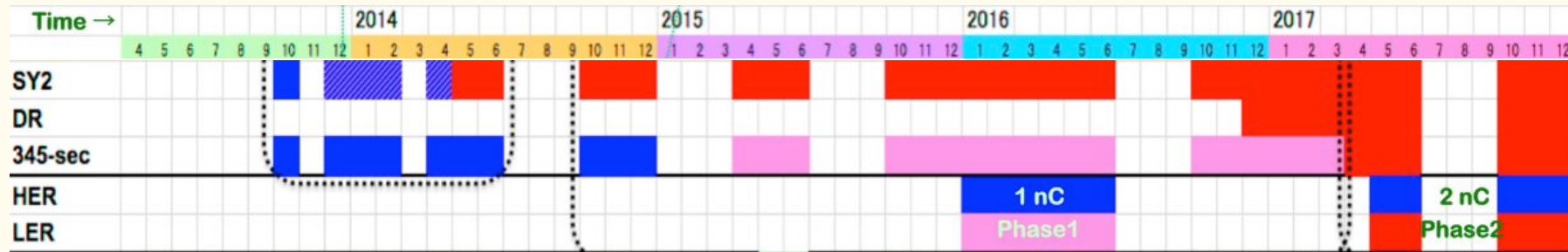

◆ Feb.2016 – Jun.2016: Phase-1 commissioning

- ❖ **Normal-emittance, 1nC/bunch electron/positron beams, without damping ring (DR)**
 - ✧ With combination of RF-gun and thermionic gun
 - ✧ ex. Electron with 1nC RF-gun, Positron with ~6nC thermionic gun
 - ◆ (depends on downstream configuration after DR delay affecting PF/PF-AR injections)

◆ Jan.2017 – May.2017, Damping ring commissioning

- ❖ **1nC – 2nC/bunch positron beam, to/from DR**

◆ Jun/Oct.2017 – Feb.2018, Phase-2 commissioning

- ❖ **Low-emittance (20mm.mrad, 0.1%), 2nC electron/positron beams, with DR**
 - ✧ Low-emittance electron beam with RF-gun, 2nC
 - ✧ Primary beam for positron with RF-gun or thermionic gun, 5nC

◆ Oct.2018 – ..., Phase-3 commissioning

- ❖ **Low-emittance (20mm.mrad, 0.1%), High charge electron/positron beams, with DR**
 - ✧ Low-emittance electron beam with RF-gun, 4nC
 - ✧ Primary beam for positron with RF-gun or thermionic gun, 10nC



Radiation protection licenses

- ◆ **Staged upgrade of beam limits**
- ◆ **Final goal is 1250/625 nA before/after target**
 - ❖ **Same as KEKB (with limited shields)**
- ◆ **Applications**
 - ❖ **Fall.2013. 10 nA at #28 dump, 1250 nA at #A2 dump**
 - ❖ **Spring.2014. New utility rooms, 50 nA at #61 straight dump**
 - ❖ **Feb.2015. 200 nA at #15 target**
 - ❖ **Late 2015.(?) 800 nA at #15 target, 625 nA at #61**
 - ❖ **Sometime 2016.(?) 1250 nA at #15 target**



Summary

- ◆ **Steady progress towards first MR injection in 2015**
- ◆ **Finished earthquake disaster recovery in 2014**
- ◆ **Will make staged improvements up to Phase-III**
- ◆ **Alignment: almost confident on the required precision (0.1-mm local, 0.3-mm global), need to maintain for longer term**
- ◆ **RF gun: following recommendations at review meetings with commercial devices and Nd-based lasers**
- ◆ **Thermionic gun: waiting to be commissioned**
- ◆ **Positron generator: waiting for license test**
- ◆ **Will balance between final beam quality and staged operation**
- ◆ **Will select optimized route depending on available resources**

