

# SUPERKEKB 入射器における RF 電子銃用レーザー安定性と 出力エネルギーの高性能化の検討

## STUDY ON STABLE AND HIGH OUTPUT ENERGY LASER SYSTEM FOR RF-GUN AT SUPERKEKB INJECTOR

張睿<sup>#, A), B)</sup>, 周翔宇<sup>A), B)</sup>, 夏井拓也<sup>A), B)</sup>, 佐藤大輔<sup>A)</sup>, 吉田光宏<sup>A), B)</sup>

Rui Zhang<sup>#, A), B)</sup>, Xiangyu Zhou<sup>A), B)</sup>, Takuya Natsui<sup>A), B)</sup>, Daisuke Satoh<sup>A)</sup>, Mitsuhiro Yoshida<sup>A), B)</sup>

<sup>A)</sup> High Energy Accelerator Research Organization (KEK)

<sup>B)</sup> The Graduate University of Advanced Studies (SOKENDAI)

### Abstract

SuperKEKB phase I commissioning finished in 2016, according to the results of RF gun and laser system operation, some improvements are under doing for achieving more stable laser system. Neodymium laser system is decided to be used for SuperKEKB phase II commissioning. Meanwhile, another RF gun is built for electron generation. In order to realize reliable and continuous laser operation for RF gun, a backup Neodymium solid state laser system will be built recently. Spatial filter will be adopted for getting high laser beam quality. On the other hand, Ytterbium laser system will be used in SuperKEKB phase III. Ethanol cooling system is under designing to generate high laser output energy with good laser beam quality to remove thermal effect under high repetition rate.

### INTRODUCTION

With the aim of achieving SuperKEKB project demands on electron beam with high charge and low emittance, RF gun is adopted as electron generator. Since the RF gun processes strong focusing electric field and high accelerating efficiency, it is possible to generate high quality electron beam for accelerator. Thence, hybrid laser system which consist with of fiber laser and thin disk laser is used to generate UV laser for Iridium Cerium photocathode with high quantum efficiency inside the RF gun [1]. According to this basic guideline, an Ytterbium (Yb) hybrid laser system has been exploited and applied for SuperKEKB phase I commissioning. About 1.5 nC electron is generated successfully and injected into SuperKEKB High Energy Ring (HER) in 2016 summer. Meanwhile, 10 days stable injection with 1 nC is also accomplished smoothly for the first time.

According to the commissioning results of SuperKEKB phase I, a lot of improvement should be done for low emittance and high charge experiment in the following phases. Stability of laser operation is the most important issue. Thermal effect of the thin disk laser part was serious because the combination method of Yb:YAG thin disk and heatsink. Inefficient thermal removal induced thermal lens effect, it increased the instability of laser system. More efficient thermal removal method should be explored for laser operation under high repetition rate in

the future. Meanwhile, stable temperature of laser room is also important for stable laser operation. Necessary temperature management should be done. In addition, low emittance of electron beam is very important for the later phase commissioning. Although the RF gun design processes strong focusing electric field, the laser beam quality and space profile are also important to generate high quality electron beam. Therefore, besides the increasing of laser pulse energy, the reshaping of laser beam also should be explored for SuperKEKB phase II. Spatial filter will be designed and used to increase the laser beam quality for phase II laser system.

SuperKEKB Phase II will start from the end of this fiscal year. With the aim of achieving the demand on electron charge of 2 nC, an additional Neodymium (Nd) laser system is prepared and tested. By using of Nd:YAG rod laser modules, about 150  $\mu$ J UV laser is generated for RF gun. Accordingly, 1.5 nC electron charge is gotten at 25 Hz operation [2]. Basing on the Phase I commissioning results, laser box is built for more stable laser operation to improve the space stability of electron charge. Additionally, in order to get high laser beam quality, spatial filter is under designing and will be installed in backup line of Nd:YAG laser amplifier. At the beginning of this year, another new RF gun was installed at 90 degree arrangement. New UV laser generation part is designed in tunnel which makes one laser system be available to two RF guns. Meanwhile, remote control monitoring and measurement system will be inserted into for real time checking green laser and UV laser beam quality, as well as the pulse energy during commissioning.

SuperKEKB phase III operation will still use the Yb hybrid laser system. For 25 Hz double pulses or 50 Hz laser operation, more efficient thermal management should be considered. Therefore, more excellent combination method of Yb:YAG and heatsink will be adopted. In order to generate high laser output energy with low nonlinear effect, low temperature laser system is necessary. At the same time, it is also available to avoid serious thermal effect. Peltier cooling laser is tested, gain of laser is higher than ambient laser operation. However, not enough refrigerating effect as well as temperature instability are not suitable to stable laser operation. More effective ethanol cooling laser system is under investigation.

## NEODYMIUM LASER SYSTEM FOR SUPERKEKB PHASE II COMISSIONING

A hybrid laser system which is made of Yb-doped fiber part and Nd:YAG rod laser modules part has been built for SuperKEKB phase II. The layout of this laser system is shown in Figure 1. Seed laser is generated by a mode lock Yb-doped fiber oscillator, then it is amplified by Yb-doped fiber pre-amplifiers. The pulse width of seed laser is stretched into about 10 ps by transmission grating pair. Because the spectrum of seed laser is broad, 1030 nm and 1064 nm components can be selected by use of a grating and slit. The selected two parts are injected into 1030 nm and 1064 nm amplifier system. For phase II laser system, the following active material is Nd:YAG, the 1064 nm laser is chosen and amplified gradually. Changing the repetition rate into 25 Hz by using of E.O. module, 4 stages of Nd:YAG rod laser modules are adopted for building multi-pass amplifiers. Low gain type modules are used for multi-pass amplifier 1 and 2. Both of them has 2 pass configuration. The other type, high gain module, is used for 4 pass amplifier 3 and 2 pass amplifier 4. After all the amplifiers, about 3.0 mJ pulse energy is achieved at 1064 nm.

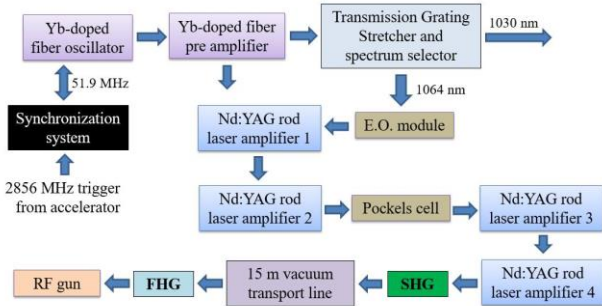

Figure 1: Layout of the Nd hybrid laser system for SuperKEKB Phase II commissioning.

Make use of BBO, about 1.3 mJ 532 nm green laser is generated at laser hut. In order to decrease the laser instability which is induce by air flow, a 15 m long vacuum transportation line will be built in the August. The second BBO crystal for UV laser generation will be place into RF gun box in tunnel. One laser source should be used to two RF guns, so new optics system in tunnel also will be built before this October. Details are introduce in the following two parts.

### Optics injection system for 0° and 90° RF gun in tunnel

A 90° injection RF gun is installed in the beginning of this year [3]. The layout of A1 sector at linac is shown in Figure 2. It has been tested during this spring operation. 1.5 nC electron charge is generated successfully and accelerated. In the future, this RF gun will be adopted as secondary electron source for SuperKEKB project. With the aim of realizing one laser system for two RF guns, new optics injection system is designed and will be built from this August.

The green laser is transported from ground laser hut to underground tunnel by the vacuum transporting line. Then it enters into the 0° RF gun box, as shown in the lower

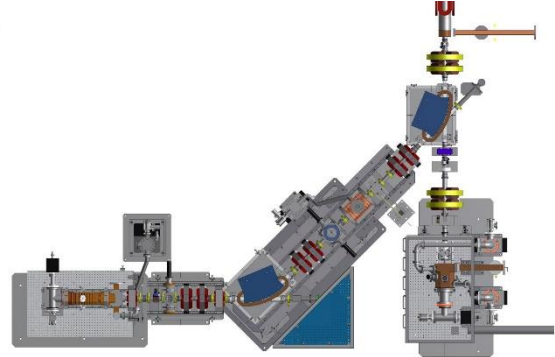

Figure 2: Layout of 0° and 90° RF gun at linac. Blue triangle zone is the optics box for 90° RF gun. Optics system for 0° RF gun is shown in the lower right corner.

right corner of Figure 2. Before the green laser impinges into the BBO crystal, a flip mirror is set to change the green laser direction for 0° and 90° RF gun. By using of this arrangement, one laser source can be available to both gun. Tow fourth harmonic generation setups are installed at 0° RF gun optical table and 90° RF gun optical table. The blue triangle zone in Figure 2 is the 0° RF gun optical table.

According to the previous electron generation history, the electron charge is closely related to the laser beam quality and pulse energy. Therefore, in order to get stable and high electron charge, remote control monitoring and measurement system are very important for phase II commissioning. Remote control flip mirror will also be inserted into the laser transportation line for reflecting the UV laser onto energy sensor to realize real time measuring. In addition, the green laser beam profile can be monitor by remote control beam profile monitor. During the operating time of RF gun, the adjustment of laser system is operable according to the measured laser beam profile.

### Spatial filter for backup line of Nd rod laser amplifiers

As mentioned above, electron charge generated by the RF gun is closely related to the laser beam quality, not only to the laser pulse energy. Meanwhile, excellent injection laser beam quality is very helpful to generate low emittance electron charge. Distinguished from the regenerative amplifier, amplified laser beam quality by use of multi-pass amplifier is not good. Moreover, bad thermal management of rod laser configuration also decreases the beam quality. Therefore, spatial filter is necessary for cleaning the amplified laser beam after all the Nd:YAG rod laser amplifiers.

For ensuring SuperKEKB phase II commissioning, a backup line of Nd:YAG laser system will be built next to the current laser system. High gain laser modules will be used in this line, as well as the spatial filter. By calculation, three types of slits and pinholes are designed,

in order to achieve exchange easily, all the slits and pinholes are manufactured on one thin tungsten plate, as shown in Figure 3. By use of feedthrough, the proper slit and pinhole can be chosen, which is basing on the incident laser beam size. Cross shape slits are prepared for vertical and horizontal directions beam cleaning with the help of cylindrical lensed. The whole length of it is about 3 m, focusing lenses are placed outside the vacuum pipe for flexible adjustment.

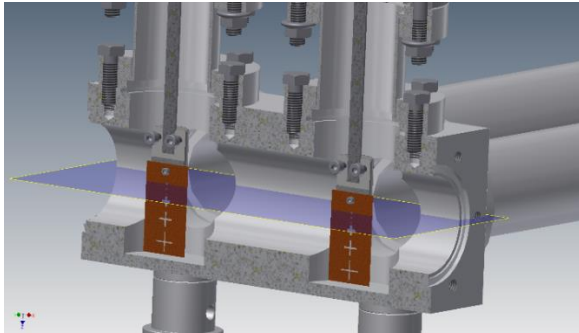

Figure 3: Cross section of spatial filter for Nd:YAG laser system. The plane shown in the figure is the laser injection plane.

For the purpose of decreasing the vibration that is induce by scroll pump, vacuum valve should be used. Scroll pump only works during the vacuum level is not good, the other time vacuum situation can be kept by the valve to stop scroll pump for the stable laser operation. Back up line and spatial filter building will started in the following days.

### YTTERBIUM LASER SYSTEM FOR SUPERKEKB PHASE III

A hybrid laser system which is made of Yb-doped fiber part and Yb:YAG thin disk amplification part will be explored for SuperKEKB phase III. The laser system framework is shown in Figure 4. The seed laser and fiber amplifier are almost the same as them of Nd hybrid laser system. In order to decrease the thermal effect, thin disk laser configuration will be utilized. Because regenerative

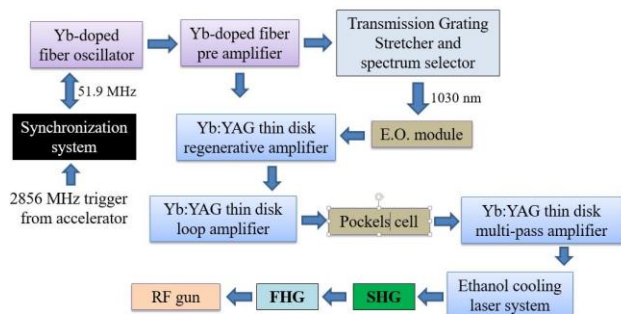

Figure 4: Layout of Yb hybrid laser system for SuperKEKB phase III commissioning.

amplifier can realize high amplification factor, at the same time, the amplified laser beam quality is better due to the mode selection of regenerative amplifier cavity. Then, a thin disk loop amplifier will be built due to it has high

amplification factor. After that, normal Yb:YAG thin disk multi-pass amplifier will be adopted. Compare with the regenerative amplifier and loop amplifier, the amplification factor is not so high for normal multi-pass amplifier, but big laser beam amplification is suitable to high energy laser amplification. It prevents from damaging of optical components and laser crystals, also decreasing the nonlinear effects. The last amplifier is ethanol cooling amplifier. Low temperature cooling laser is very suitable to release the thermal effect and increase the gain of amplifier. For testing the low temperature laser characteristics, low temperature laser operation which is achieved by Peltier plates is tested before ethanol cooling experiment.

### Low temperature laser test

By using of the compact vacuum chamber and Peltier plates,  $-40^{\circ}\text{C}$  is achieved for laser operation. The setup is shown in Figure 5. A dichroic mirror is used to realize face pump and seed laser face injection arrangement, which is placed before a window of the vacuum chamber. 3.3 kW pump laser is focused on the surface of Yb:YAG disk with an area of 8 mm x 6 mm at repetition rate of 25 Hz. The 1 mm thick Yb:YAG thin disk is soldered onto a CuW heatsink by indium soldering method [4]. Input seed laser pulse energy is about 1.5 mJ with beam radius about 4 mm.

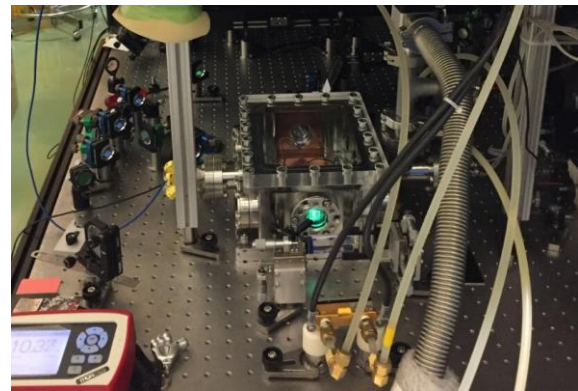

Figure 5: Experiment setup of Peltier cooling 3 pass multi-pass amplifier stage.

3 passes amplifier is built for testing the amplification factor. Laser pulse energy for every pass is shown in Figure 6. After 3 pass amplification, 11.6 mJ laser pulse energy is achieved. This pulse energy is almost same as the energy of laser system which is used in SuperKEKB Phase I, but pass number of multi-pass amplifier is much less [4]. Obviously, the amplification factor is higher at low temperature operation, so less amplifier stage can be adopted to reduce the size of laser system and improve the stability. In addition, it is very helpful to decrease the unwanted nonlinear effect inside the Yb:YAG crystal by using of bigger pump size and seed laser beam size. Although the low temperature operation can be realized by the Peltier plates, the temperature stability is a question. With the change of temperature, the amplified laser pulse energy changes. It causes the electron charge

generated by RF gun to fluctuate. In addition, the cooling capability of Peltier plate is not enough for higher laser amplification.

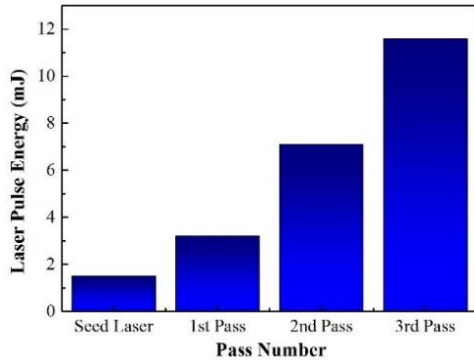

Figure 6: Laser pulse energy of the Peltier cooling multi-pass amplifier under 3.3 kW pump laser.

### Ethanol Cooling Laser Amplifier

According to the amplification results of low temperature experiment, it is known that the low temperature laser operation is very efficient. Comparing with cryogenic laser experiment, amplification factor of low temperature is not so high, but the gain spectrum of laser crystal is broader than that at cryogenic temperature. It is suitable to do laser pulse shaping for generating electron beam with low emittance. Therefore, we will build a low temperature laser amplifier for SuperKEKB phase III.

Due to the insufficient cooling capability of the Peltier cooling plate, Stirling refrigerator is chosen for low temperature laser operation. Because the freezing point of ethanol is low than  $-100\text{ }^{\circ}\text{C}$ , it will be used as refrigeration fluid. Operation temperature will be set from  $-100\text{ }^{\circ}\text{C}$  to  $-80\text{ }^{\circ}\text{C}$ , this temperature is enough for our low temperature laser experiment. Moreover, the gain spectrum width is not narrow. The experiment setup design is finished, as shown in Figure 7. Homemade Yb:YAG/CuW laser head will be placed into a small chamber. This experiment will be started and tested in this winter, it is also the final amplification for generating high charge electron beam during SuperKEKB phase III commissioning.

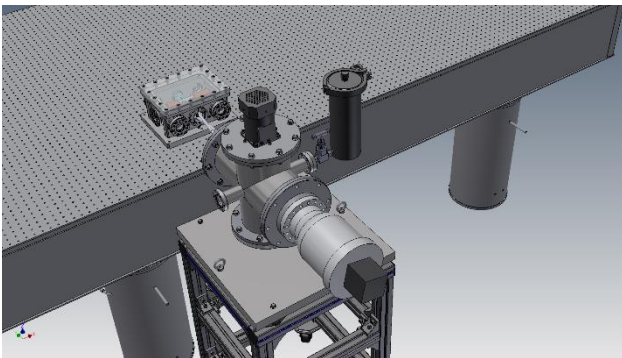

Figure 7: Designed experimental ethanol cooling laser amplifier.

## CONCLUSION

A new hybrid laser system have been being done for SuperKEKB phase II commissioning basing on the operation results of SuperKEKB phase I. It consists of Yb doped fiber laser and Nd:YAG rod laser module multi-pass amplifier part. About 3 mJ 1064 nm laser is generated, 200  $\mu\text{J}$  UV laser will be used for RF gun. Another new RF is installed as the secondary electron source for phase II operation. Accordingly, new laser optics system for two RF guns will built to realize one laser system application for two guns. In addition, in order to generate electron charge with low emittance, spatial filter will be inserted after all the Nd:YAG rod laser amplifiers.

Furthermore, low temperature laser amplifier is tested for getting high laser pulse energy, which is available to our homemade new Yb:YAG disk laser head. Compare to the ambient and cryogenic laser operation, it is more efficient with broader gain spectrum. As to SuperKEKB phase III operation, this is very suitable to do laser pulse shaping for obtaining high charge electron with low emittance. An ethanol cooling laser amplifier is design and will be built at the end of this year.

## REFERENCES

- [1] M. Yoshida *et al.*, "SuperKEKB injector upgrade for high charge and low emittance electron beam", in *Proc. IPAC'12*, New Orleans, USA, paper TUPPD035.
- [2] X.Y. Zhou *et al.*, "Yb fiber and Nd:YAG hybrid laser system of RF gun for SuperKEKB's phase-II commissioning", presented at *PASJ'17*, Sapporo, Hokkaido, this conference.
- [3] T. Natsui *et al.*, "RF gun development for SuperKEKB", presented at *PASJ'17*, Sapporo, Hokkaido, this conference.
- [4] R. Zhang *et al.*, "Developing an Yb/Nd doped Hybrid solid state laser of RF Gun for SuperKEKB Phase II commissioning", in *Proc. IPAC'17* Copenhagen Denmark, paper TUPAB056.