



WEO1T01

First synchrotron injection attempt into the SuperKEKB HER

IPAC
2026

17th International
Particle Accelerator Conference

May 17 - 22
Deauville | Normandy | France

2026 May 20
IPAC2026
N. Iida, KEK

Co-authors: Y. Funakoshi, H. Kaji, T. Kamitani, M. Kikuchi, K. Kodama, H. Koiso, M. Li, T. Mimashi, G. Mitsuka, T. Mori, Y. Ohnishi, K. Oide, Y. Seimiya, K. Shibata, H. Sugimoto, M. Tawada, T. Ueda, R. Ueki, T. Yoshimoto
Many thanks to the all members of SuperKEKB (Linac/Ring) and MELSC operators.

First synchrotron injection attempt into the SuperKEKB HER

Contents

- Introduction
- Why synchrotron injection ?
- Injection commissioning of the synchrotron injection
- Simulations
- Summary

Injection limits luminosity

The injection status at the new peak luminosity record (5.24×10^{34}) in March 2026

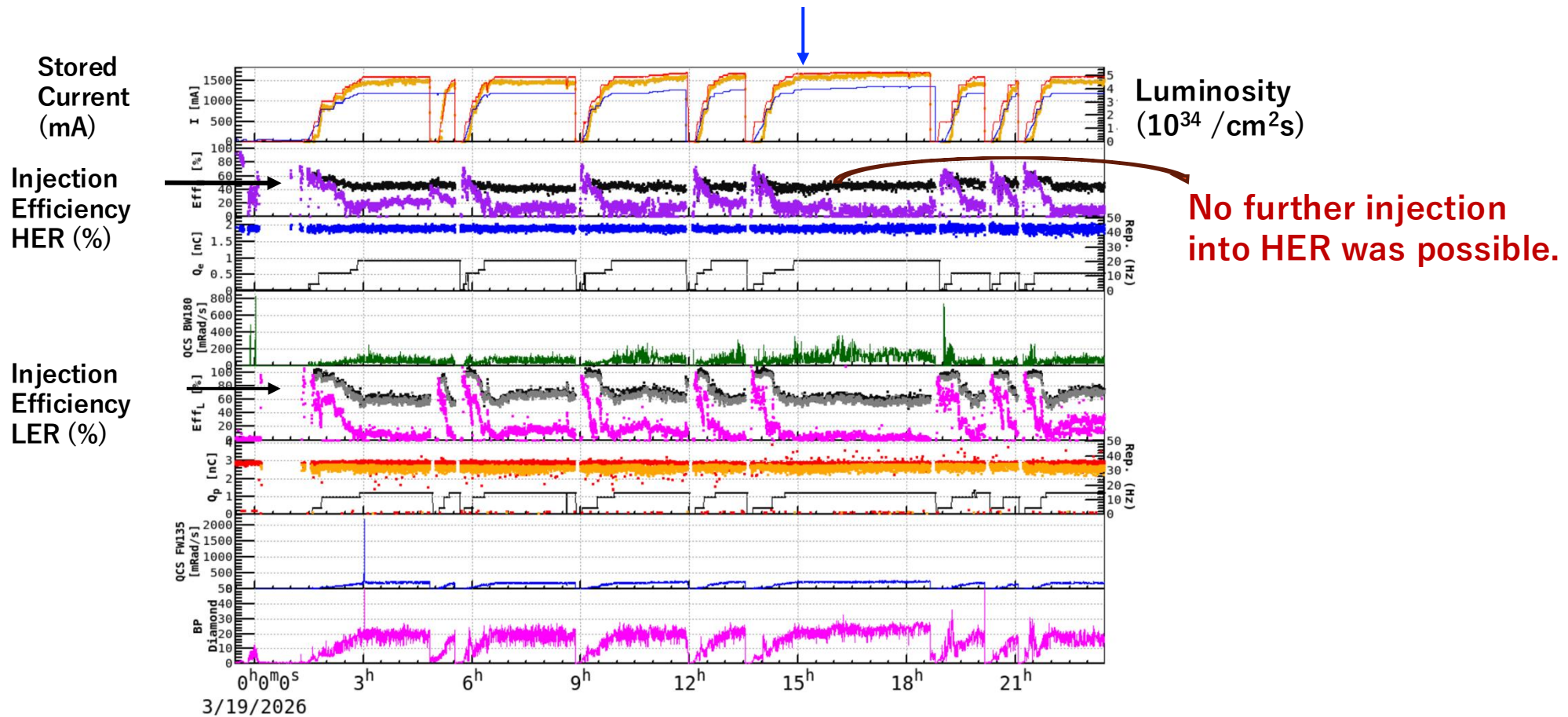

The stored current of HER was limited by,

- Linac bunch charge (1.8nC/pulse)
- Repetition rate (21Hz)
- Injection efficiency (~50%)
- Beam lifetime (~12 min)

← Each parameter must be improved for higher luminosity!

Layout of Injector

Linac and BT (Beam Transport line)

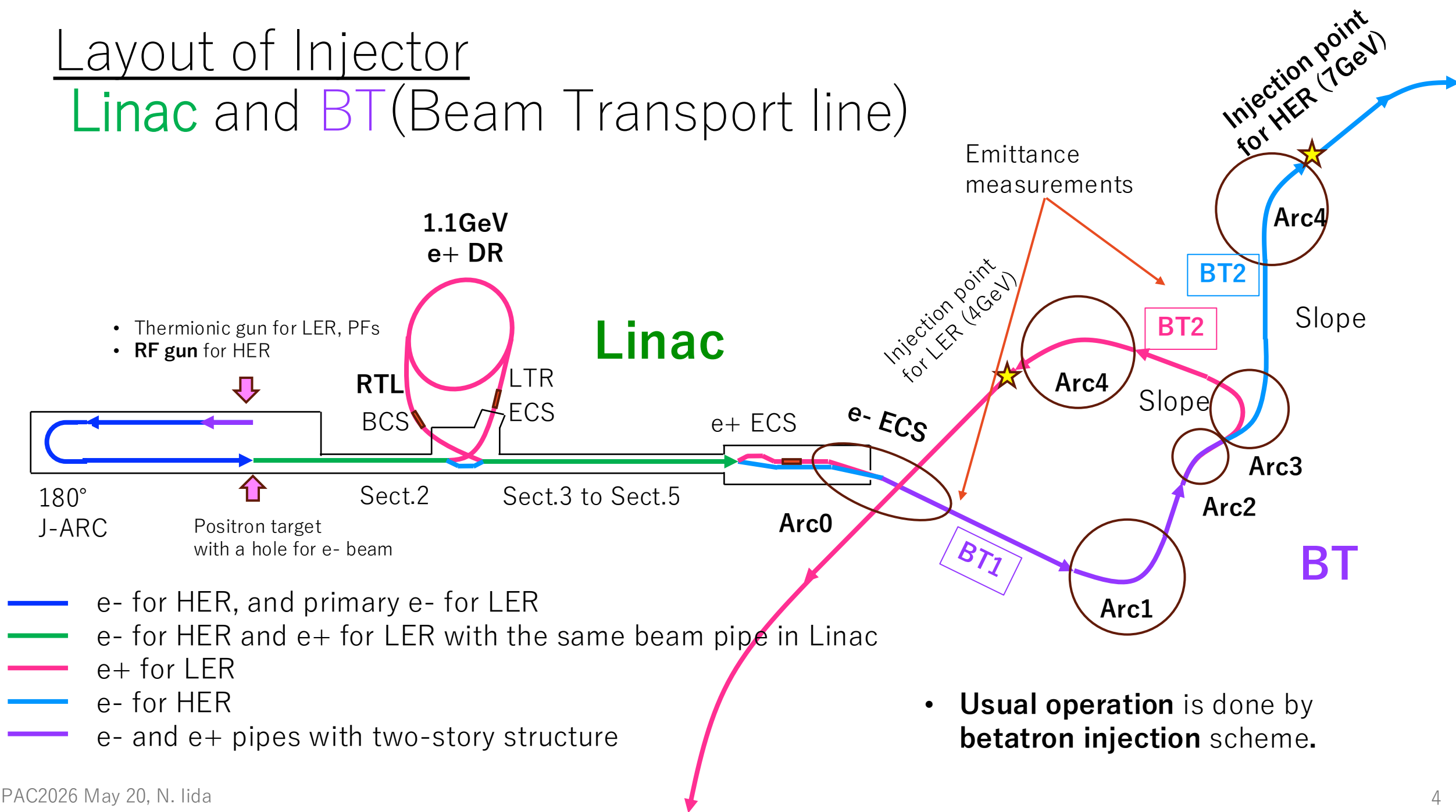

Why synchrotron injection (SI) ?

The injection oscillation is converted from the horizontal to the longitudinal in SI.

- The horizontal orbit oscillation in the no-dispersive region became almost eliminated

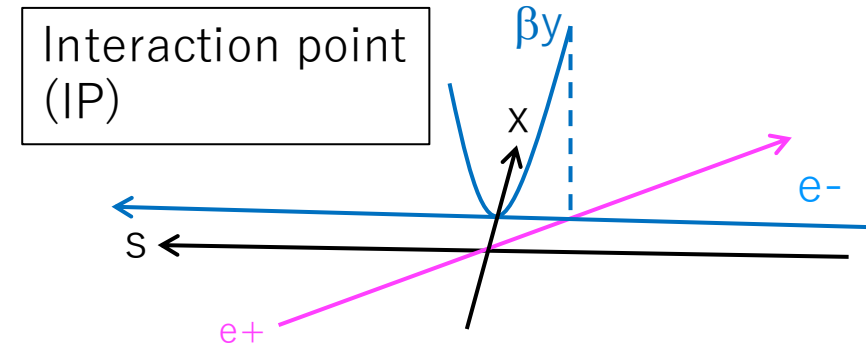

	BI	SI
Beam-beam kick at IP	Large H. oscillation	No H. oscillation
Beam-beam with nano-beam	H. osci. causes shift of $s \rightarrow$ large β_y	(Coll. at $s \sim 10\sigma_z$)
Dynamic aperture (DA)	Large H. osci. decreases V. DA	No H. osci.
SR to the IP beam pipe	Larger due to H. osci.	No H. osci.
Damping time	58 ms (Horizontal)	29 ms (Longitudinal)
Sensitivity to b-b/sext. misalignment/tune	More sensitive	Less sensitive

Action of the beams at the injection point

Betatron injection (BI)

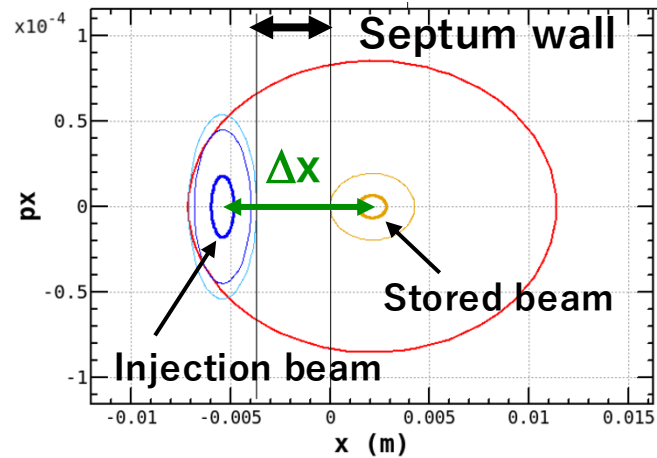

Synchrotron injection (SI)

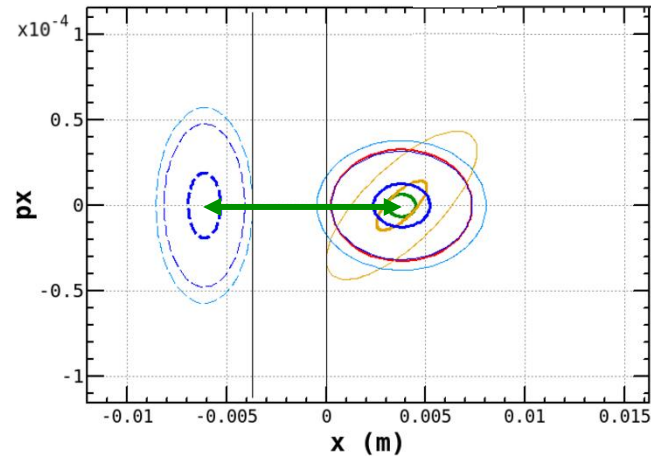

Synchro-beta injection (SBI)

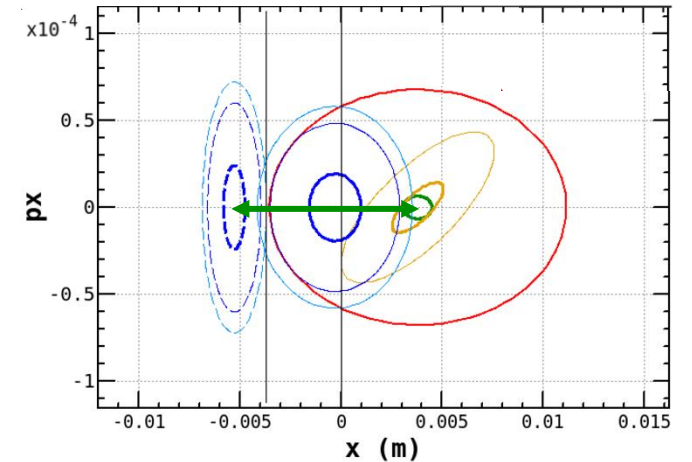

The injection beam moves within the region of this red circle.

Table 1: Injection Parameters. The subscript inj denotes the values of ring / injection beams at the virtual injection point PINJAXO.

	BI	SI	SBI
ε_x [nm]		4.6 / 10.2	
σ_δ [%]		0.063 / 0.18 ¹	
$\beta_{x,inj}$ [m]	108.4 / 31.6	108.4 / 63.9	108.4 / 27.2
$\alpha_{x,inj}$	0 / 0	0 / 0	0 / 0
$\eta_{x,inj}$ [m]	0 / 0	-1.66 / 0	-1.66 / 0
$\eta_{p_x,inj}$ at IP	0 / 0	-0.02 / -0.02	-0.02 / -0.02
$\Delta E / E$ [%]	0.0	+0.6	+0.3
$2J_x$ [μ m]	0.79	0.15	0.50

Survival ratio of injected beam from simulations (%)

	BI	SI	SBI
w/o bb	93.6±0.8	85.6±1.0	77.6 ± 1.3

- **SI is tested this time.**
- The sextupoles used in the simulation for BI are different from those used in the beam operation.

Injection commissioning

- Synchrotron injection was tried for SuperKEKB-HER.
 - Nov 6~20, 2025
 - $\beta^*_{x,y}$
 - (400, 81) mm, “detuned optics” for **four days** for vacuum scrubbing
 - (200, 8) mm for **two days** for measurement and extraction orbit tuning.
 - (100, 3) mm for **two hours**
 - (60, 1) mm for **14.5 hours collision tuning** and going to the **physics run**
 - Nov 20 10:00, 2025
 - The injection scheme was switched back to the betatron injection, because the test period was over.
 - At the SI, the injection was worse for the higher repetition rate, 12.5 Hz than 5 Hz.
 - However, this phenomenon often occurs even with BI, so it doesn't seem to be unique to SI.

Oscillation of injected beam

Complete agreement!

Simulation

Betatron injection

Synchrotron injection

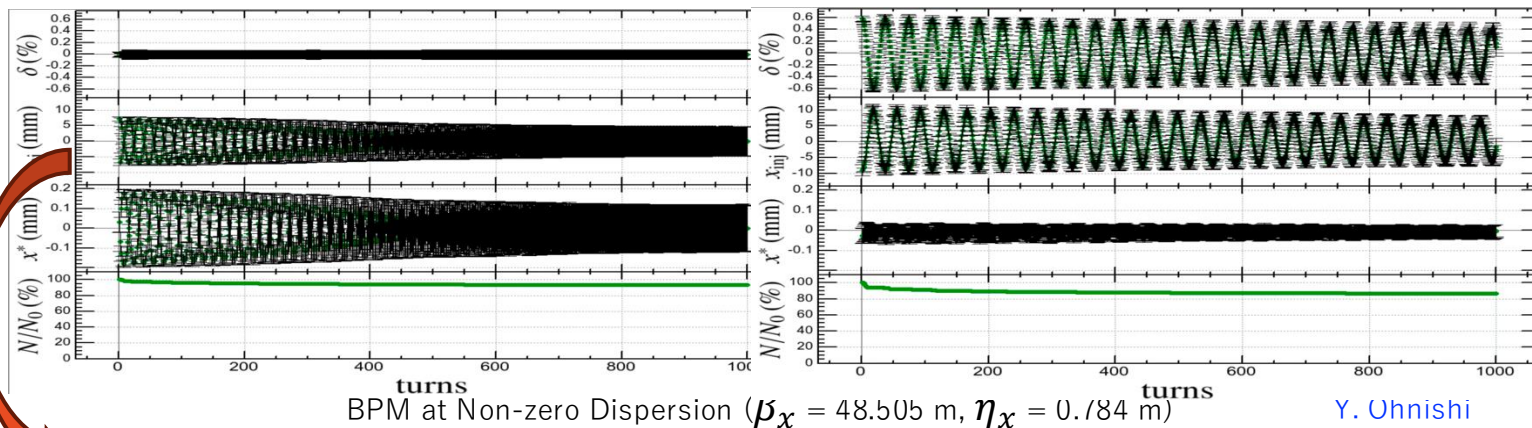

BPM at Non-zero Dispersion ($\beta_x = 48.505$ m, $\eta_x = 0.184$ m) Y. Ohnishi

Measurement

by TbT-BPM

$\beta y^* = 81$ mm

(detuned optics)

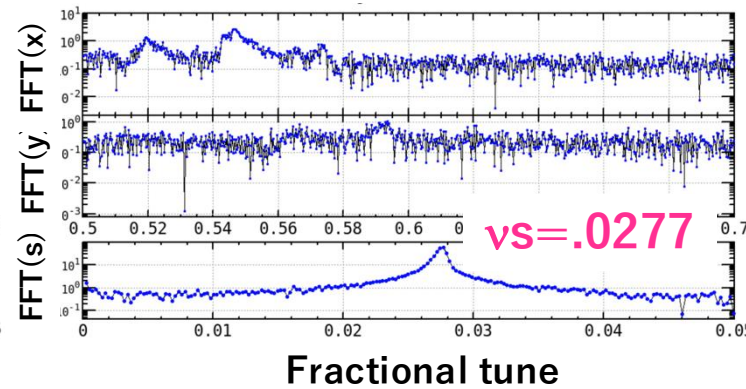
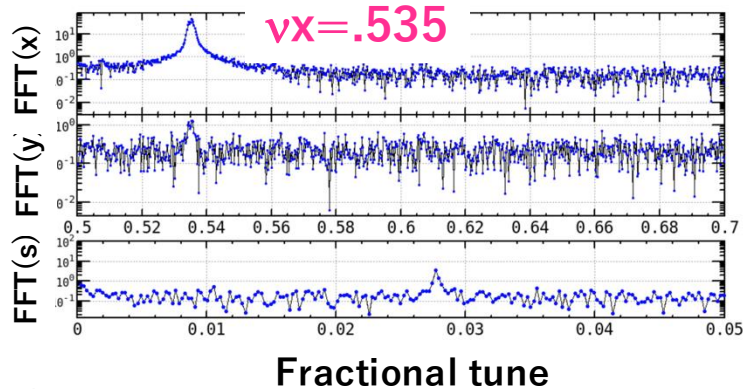
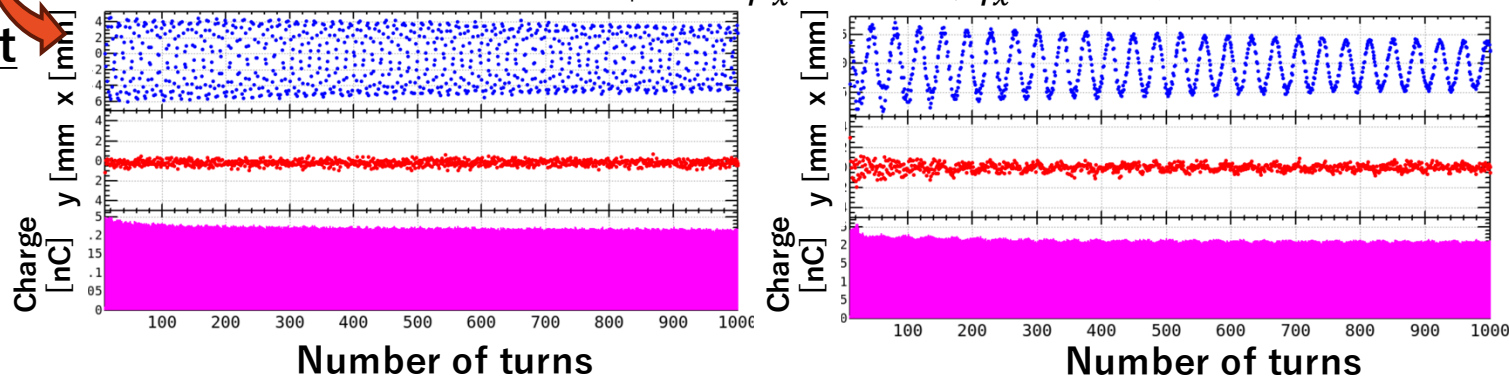

- During the detuned optics operation, the oscillations of injected beam were measured with the TbT-BPMs.
- **A significant difference in oscillation frequencies** is observed between BI and SI.
- A peak appears at the horizontal tune in the FFT spectrum of BI, while the synchrotron tune of SI.
- These results indicate a **perfect realization of the synchrotron injection**.
- The loss in the first a few turns has been indeed actually observed in the simulation.

Injection history of SI and BI at the beginning of 2025c (autumn) run of $\beta y^* = 1\text{mm}$

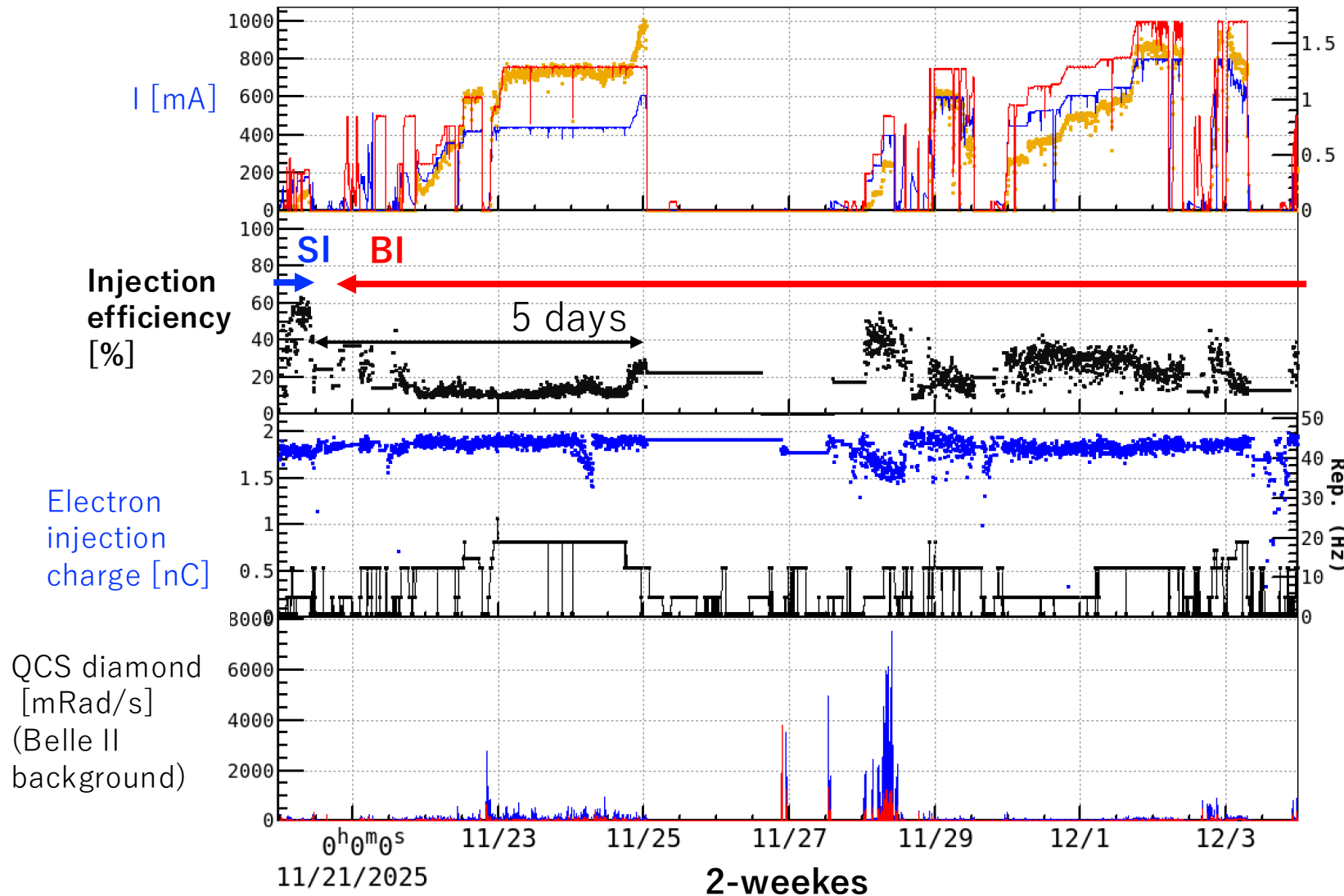

Luminosity
(10^{34})

- The injection efficiency of **SI** was achieved **60 %** only **in 6 hours**, while **BI** could not exceed **30%** even **in 5 days**.
- **In the 2025c run**, since the RF gun for HER e- beam was just changed and for the no enough tuning time, the **emittances of e- beam were quite larger** than the other runs.
- **In SI**, even with a simple injection tuning, it reached 60%.

Tracking Simulations

- Injection beam
 - Linac (by SAD)
 - Longitudinal short-range wake
 - BTe (by elegant)
 - Energy compression system (ECS)
 - CSR and ISR
- Optics matching from BTe to HER
 - Artificial matching
 - Match particles from BTe to HER's off-momentum phase space
 - Emittance scaling
 - Emittance blowup from BT1 to BT2 (~x3) has not been understood.
 - An artificial scaling was necessary.
- HER (by SAD)
 - Full 6D tracking with crab-waist optics.
 - Optional weak-strong beam-beam effects
 - No machine errors
 - 1000 to 20000 particles and 1000 to 8000 turns

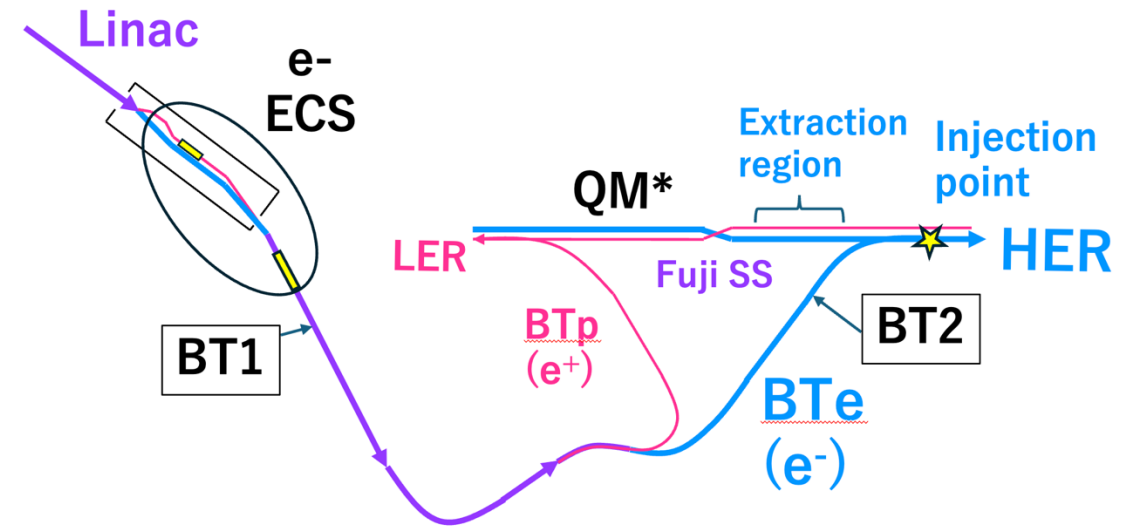

Simulation with beam-beam

SI: Synchrotron Injection
BI: Betatron Injection

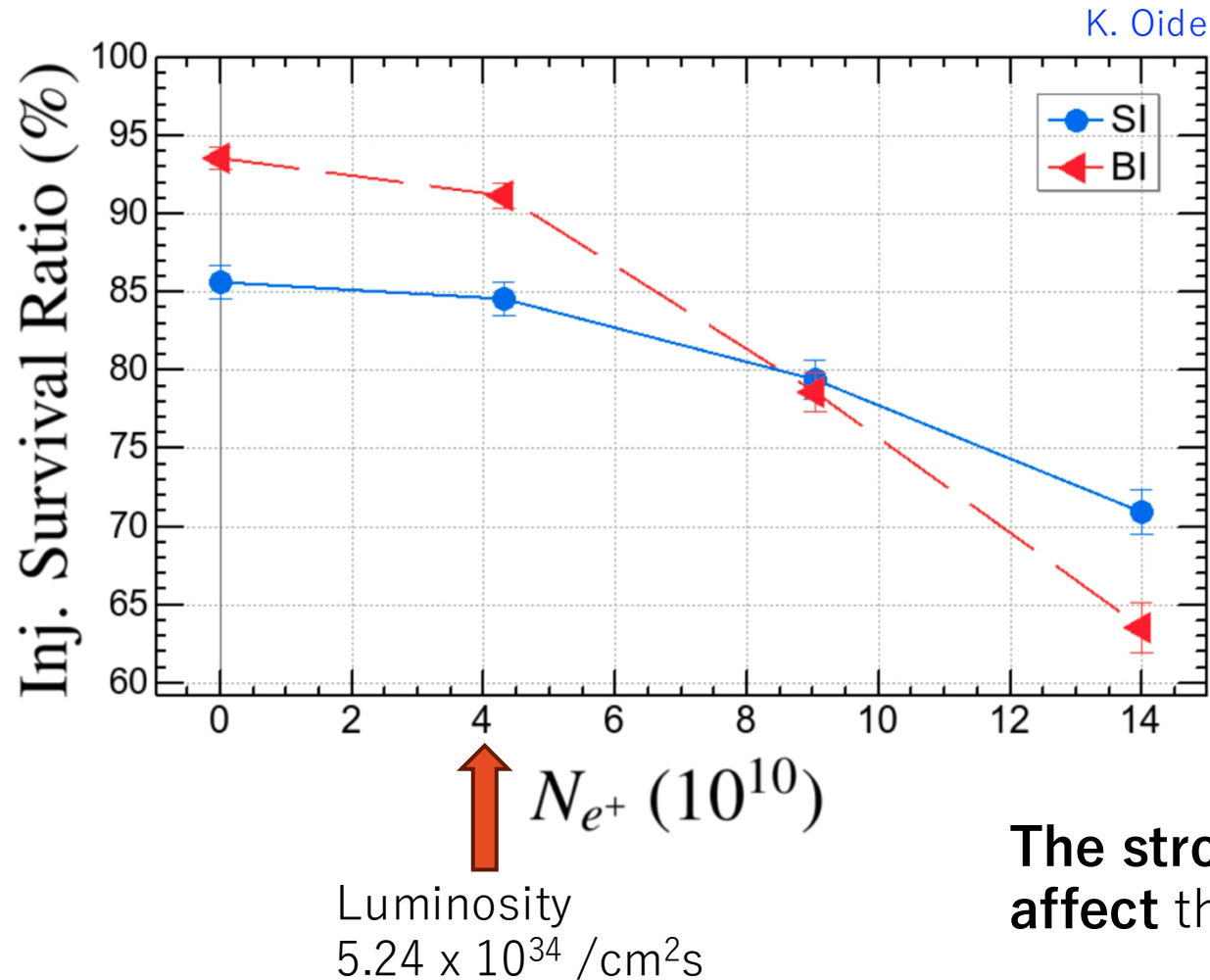

- **The simulated dependence of the injection survival ratio on the bunch population of positrons.**
- Obtained by tracking with 1000 particles after 8000 turns from injection.
- The intensity $N_{e^+} = 4.3 \times 10^{10}$ corresponds to the highest luminosity record $5.24 \times 10^{34} / \text{cm}^2\text{s}$.

The stronger beam-beam effect will affect the injection for BI than SI.

Simulation with sextupole misalignments

SI: Synchrotron Injection
BI: Betatron Injection

Y. Funakoshi

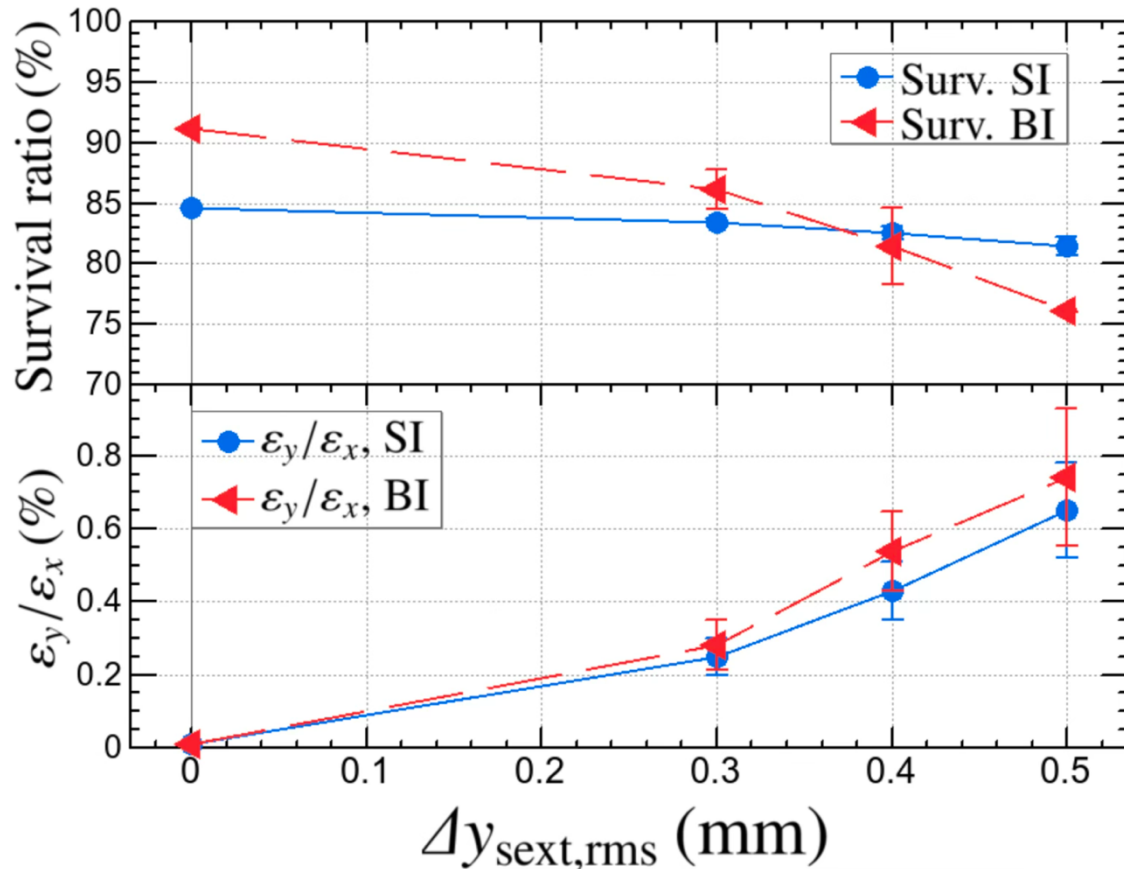

- The simulated dependence of
 - the survival ratio (upper)
 - the vertical emittance (lower)by random vertical misalignments for all sextupole magnets ($\Delta y_{\text{sext,rms}}$) in the HER
 $Ne^+ = 4.3 \times 10^{10}$.

The effect of x - y coupling on beam injection is more pronounced in BI than SI.

- This result is to be expected, as BI involves larger horizontal betatron oscillations, which may influence beam injection via the x - y coupling, touching the vertical dynamic aperture.
- **BI is much more strongly affected by beam-beam interaction and sextupole misalignments than SI.**
- This can be a motivation for SI for higher luminosities.

Simulation of tune scan of injection survival ratio

SI: Synchrotron Injection
BI: Betatron Injection

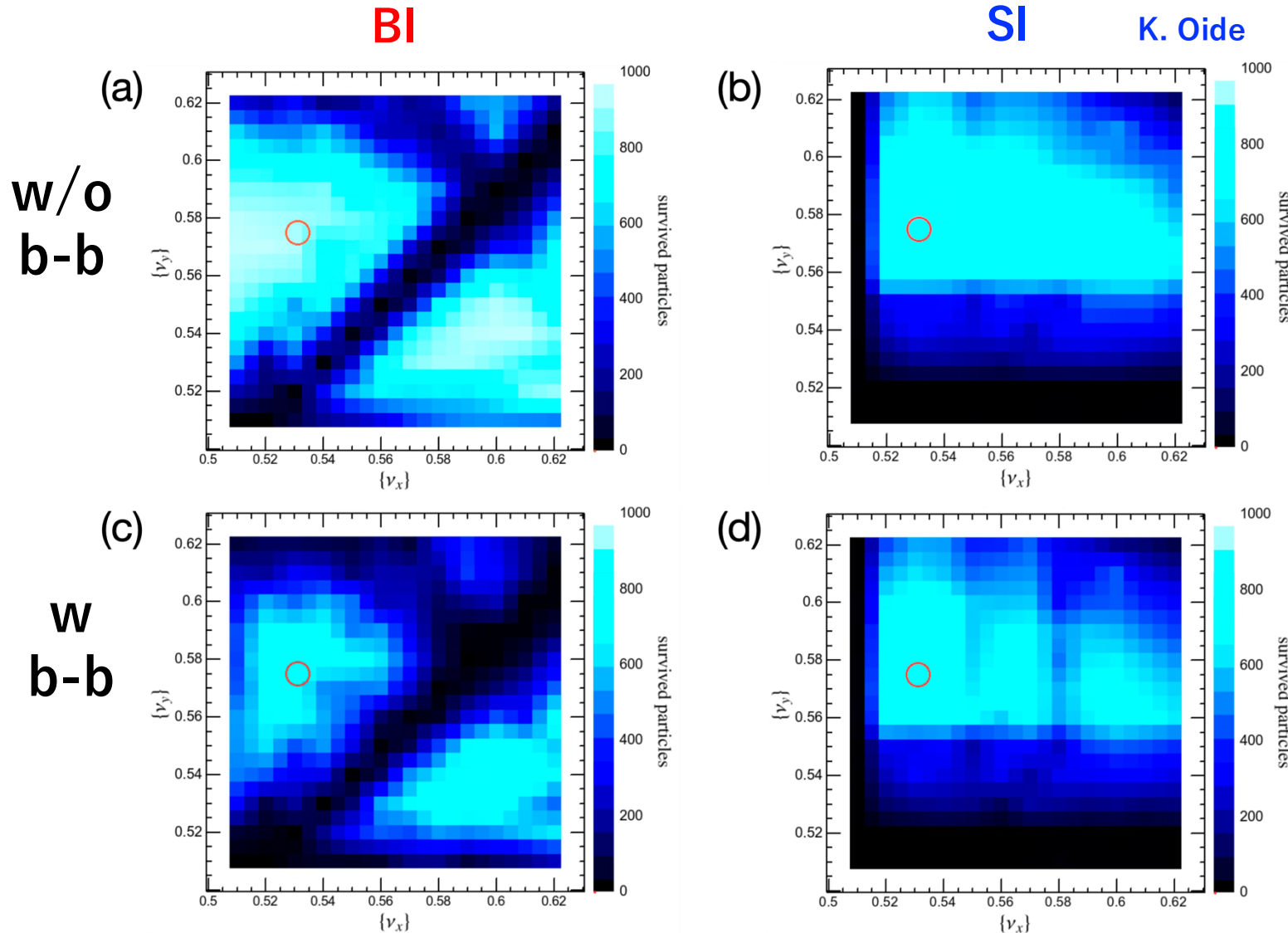

A beam-beam effect

- $Ne^+ = 9.04 \times 10^{10}$,
- (1) **Clear resonance lines $\nu_x - \nu_y \sim N$ and $5(\nu_x + \nu_y) \sim N$ are seen only for the BI, which are strengthened by beam-beam.**
- (2) There are strong dark bands if the tunes get **close to half-integer** ($\{\nu_{x,y}\} \rightarrow 0.5$) for SI. The reason for the dark bands is that the optics has **insufficient momentum acceptance** required by SI for $\{\nu_y\} < \sim 0.55$. A reconfiguration of the optics in this region seems necessary to have a larger tune space.
- (3) The differences due to beam-beam are visible in both cases, but **stronger in BI than SI.**

Photons hitting the IP beam pipe

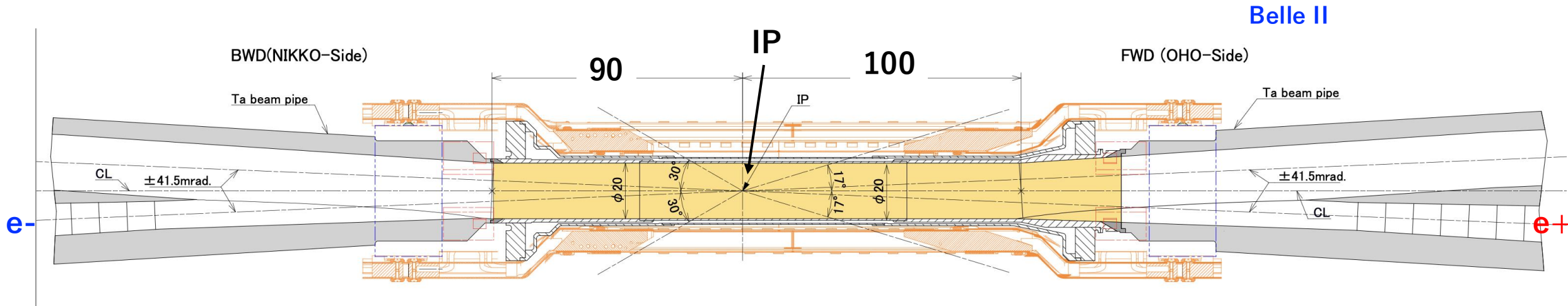

- The number of primary photons from the injected beam was estimated by tracking for the first 30 turns with 20000 particles.
- The IP beam pipe is located at ± 0.1 m from the IP, and has 10 mm inner radius, tilted to the e^+ beam by the half crossing angle 41.5 mrad.
- For **BI**, the number of photons per 1000 electrons per turn and average photon energy were **1.65 ± 0.045 and 0.37 keV**, respectively.
- For **SI**, those were **0.69 ± 0.029 and 0.39 keV**. K. Oide

- Since the Belle II-PXD detector has been turned off due to sudden beam losses, the SR background has not been measured.



Summary

- **Synchrotron injection (SI) was tested for the first time in the HER of SuperKEKB, with collision and top-up.**
- In the experiment, the injection oscillation was **fully transferred** from the horizontal **to the longitudinal plane as designed**, demonstrating the successful SI operation.
- At $\beta y^* = 1$ mm, **injection tuning was simpler than for BI**, and an **injection efficiency of ~60%** was achieved in 6 hours, while BI did not exceed 20% in 5 days.
 - Although the study was terminated due to injection difficulties at high repetition rates, likely not intrinsic to SI, a future reattempt are planned.
- **Simulations** indicated that **SI is insensitive** to collisions, sextupole misalignments, and betatron tunes.

SuperKEKB presentations in IPAC2026

- **Reduction of Sudden Beam Loss in SuperKEKB (WEP1604)**
 - Hitomi Ikeda (High Energy Accelerator Research Organization)
- **Beam Adjustment based on the Gradient Boosting Decision Tree Analysis in the KEK Electron/Positron Injector LINAC (WEP1615)**
 - Taichi Sakai (High Energy Accelerator Research Organization)
- **Precise Frequency tuning of S-band Pulse compressors in High-power operation in the electron and positron injector Linac of KEK (TUP7628)**
 - Hiroyasu Ego (KEK Accelerator Laboratory)
- **First Demonstration of High-Charge Relativistic Positron Beam Phase-Space Evolution Measurement via Complex Computed Tomography at SuperKEKB (MOP6654)**
 - Driss Oumbarek Espinos (High Energy Accelerator Research Organization)
- **SuperKEKB Beam Transport Tracking and Dynamic Aperture Comparison as an approximation for injection efficiency (SUP1007, MOP1080)**
 - Nikita van Gils (European Organization for Nuclear Research)
- **Simulations and measurements of injection backgrounds at SuperKEKB (MOP1016)**
 - Giulia Nigrelli (European Organization for Nuclear Research, Istituto Nazionale di Fisica Nucleare, Laboratori Nazionali di Frascati, Sapienza University of Rome)
- **Development and First Beam Observations of an Ultra-Fast Bunch-by-Bunch X-ray Beam Size Monitor at SuperKEKB (SUP6615, MOV6603)**
 - Riku Nomaru (The University of Tokyo)
- **Beam Dynamics Studies in the SuperKEKB Linear Accelerator and Beam Transport System (SUP1005, MOP1013)**
 - Andrea Aguirre Polo (Deutsches Elektronen-Synchrotron DESY)
- **Development of Non-Destructive Emittance Tuning System utilizing Synchrotron Radiation Monitors (MOP6653)**
 - Yuji Seimiya (High Energy Accelerator Research Organization)
- **Use of DBSCAN for full-automatic-data-based anomaly detection method on Turn-by-Turn Beam Position Monitors (TbTBPMs) in SuperKEKB (SUP1002, MOP1032)**
 - Quentin Bruant (Commissariat à l'Énergie Atomique et aux Énergies Alternatives)

Merci de votre attention



Why synchrotron injection (SI) ?

The injection oscillation is converted from the horizontal to the longitudinal in SI.

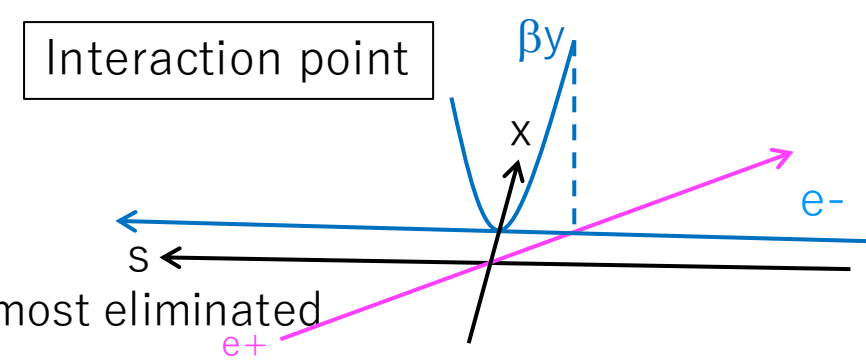

- The horizontal orbit oscillation in the no-dispersive region became almost eliminated
- **Head-on collision**
 - in general, if the injected beam undergoes **horizontal oscillation** during **top-up injection**, this beam can be kicked by the opposite beam.
- **Nano beam scheme**
 - Furthermore, in the nano-beam scheme, a **large horizontal oscillation** of the injected beam causes collisions to occur at locations with larger β_y at the IP, **resulting in stronger beam-beam kicks** and consequent beam loss. For this reason, synchrotron injection, which suppresses large horizontal injection oscillations, had been considered the design stage.
- **HER Dynamic Aperture(DA)**
 - **The horizontal oscillation** is coupled into vertical oscillation through the x-y coupling in the HER, causing **the beam to approach the vertical dynamical aperture**.
- **Synchrotron lights from injected beam towards the IP**
 - In BI, **synchrotron radiation** generated by **the horizontal injection oscillation** in quadrupole magnets strikes the beam pipe near the central chamber **contributing to the background** in the Belle II detector. In SI, the horizontal injection oscillation is eliminated.
- Shorter damping time
 - The longitudinal damping time is twice shorter than the horizontal one, so it is expected that the Belle II BG will be shorter.
- Sensitivity to sextupole misalignments and tune variation
 - To be confirmed by simulations

HER optics

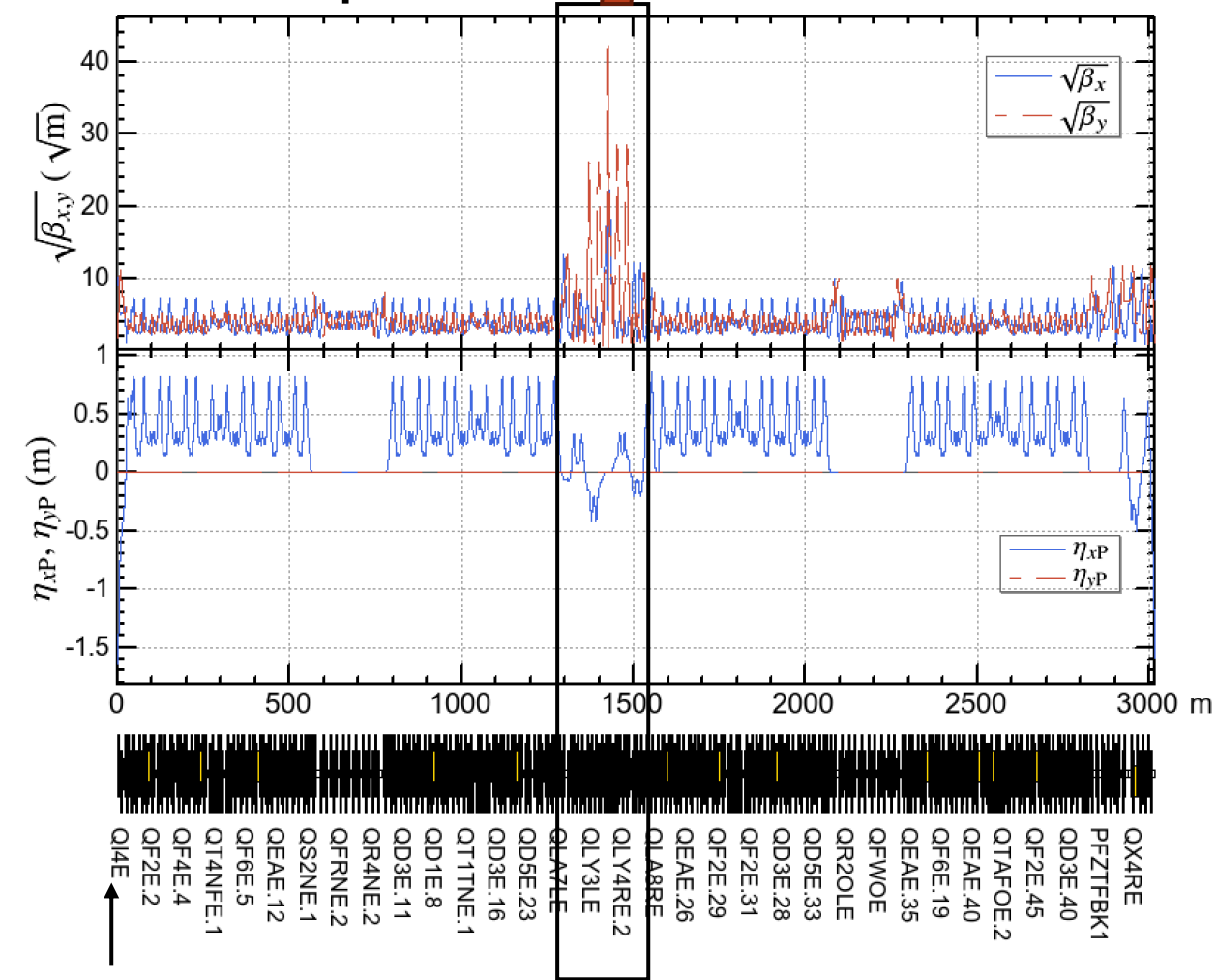

Injection point

Interaction region

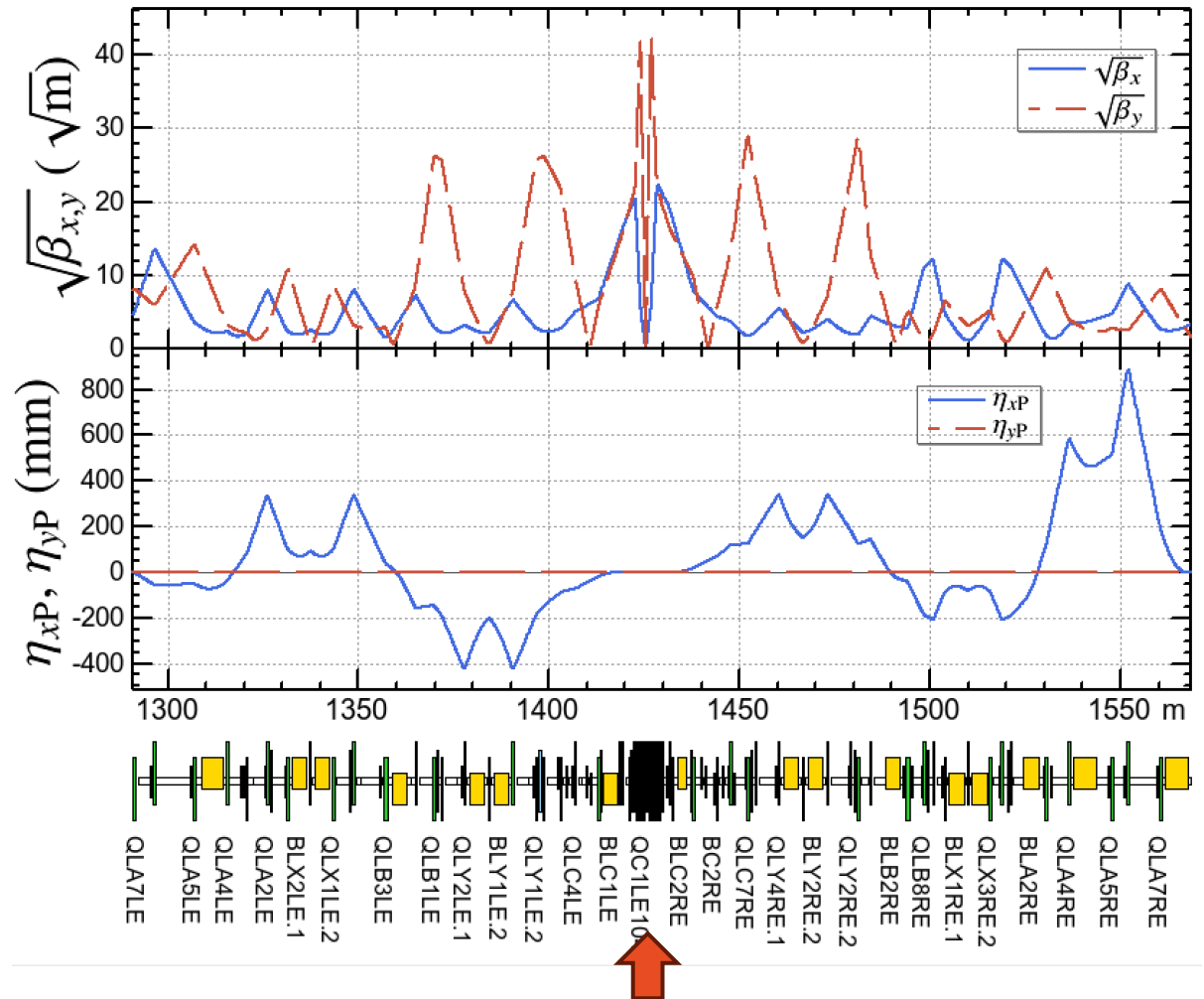

There is no dispersion at the interaction region by design.

Betatron injection

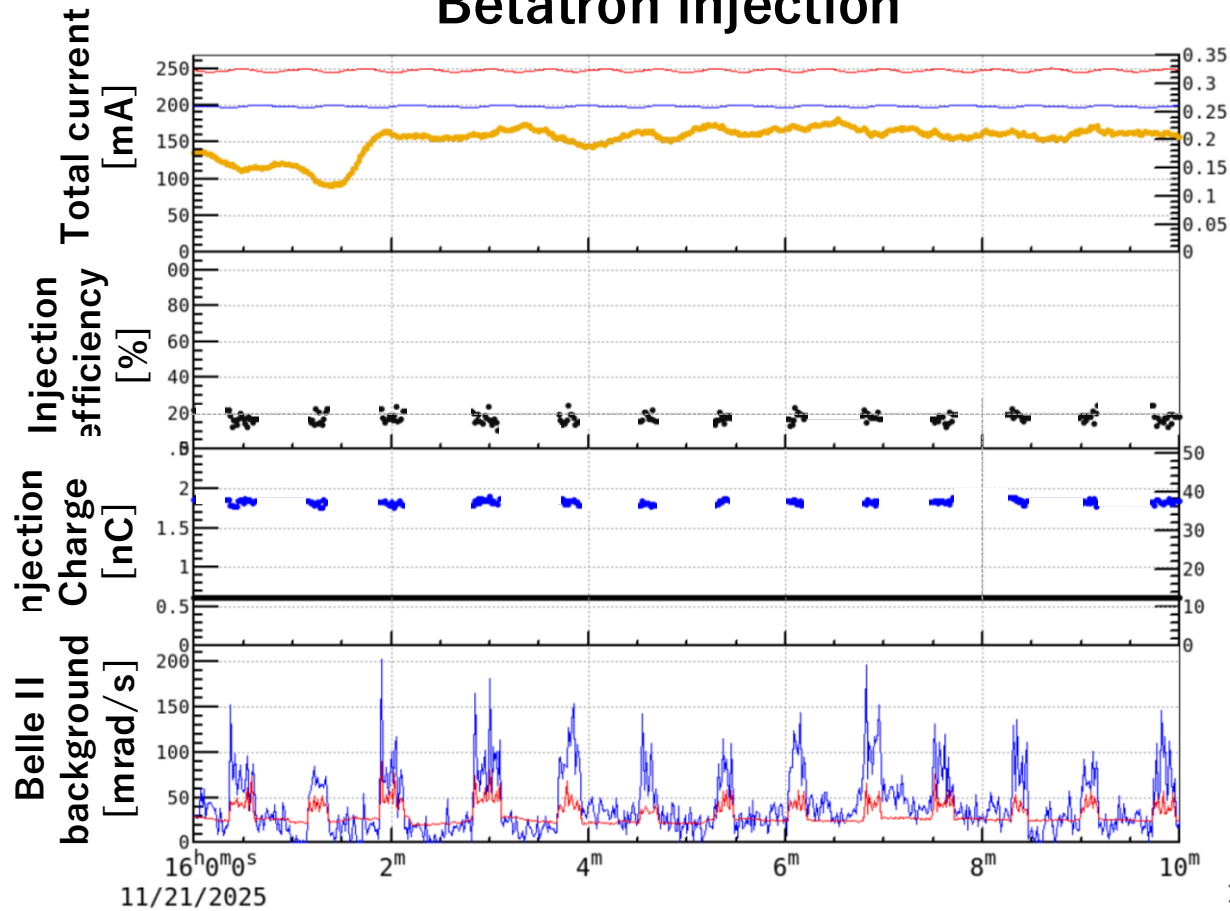

Synchrotron injection

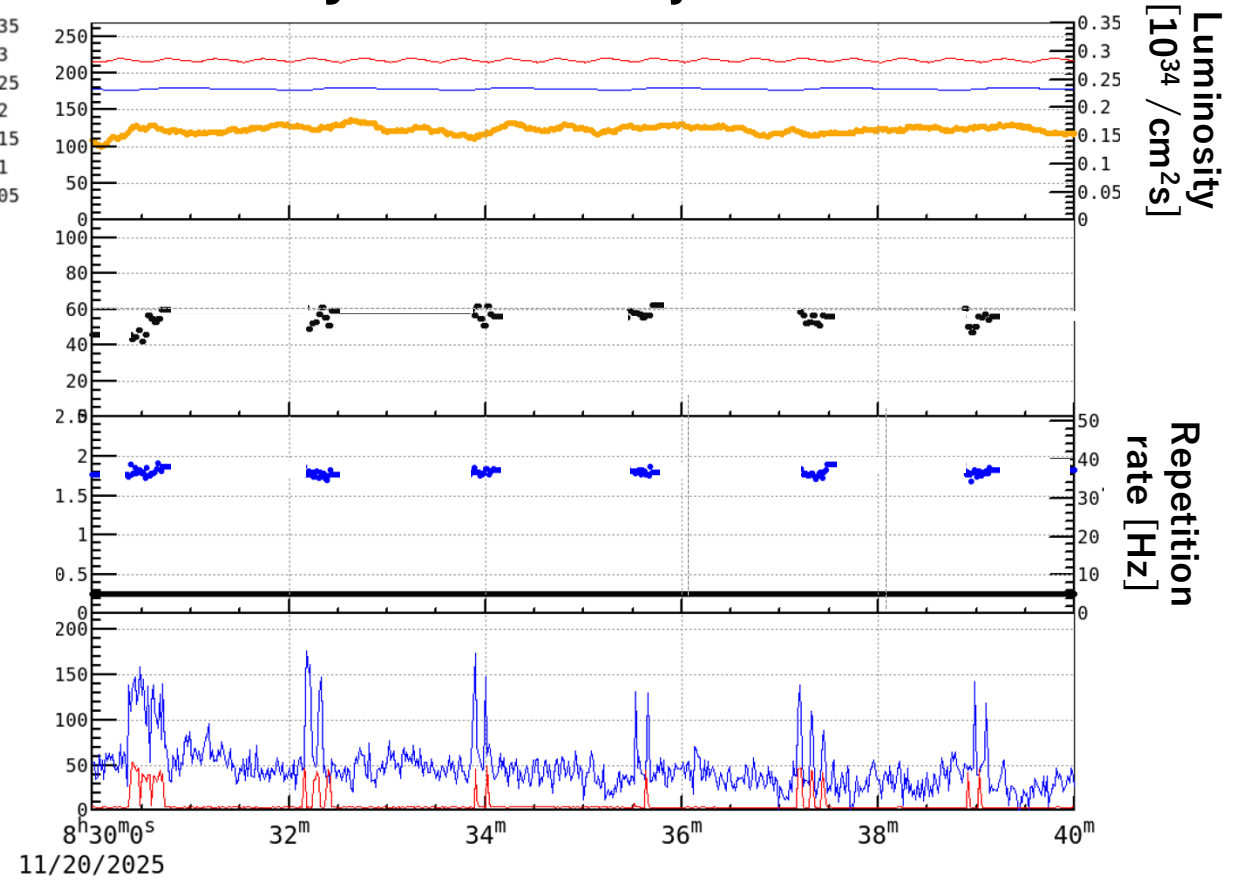

- The Belle II backgrounds were almost same for both injections. (In the next run in 2026, the emittance of the e- injection beam has been tuned well, so the injection efficiency of BI became 80% in maximum.)

HER emittances

2024c

e- Measured emittance in BT, Bunch charge, Injection efficiency, and parameters in HER

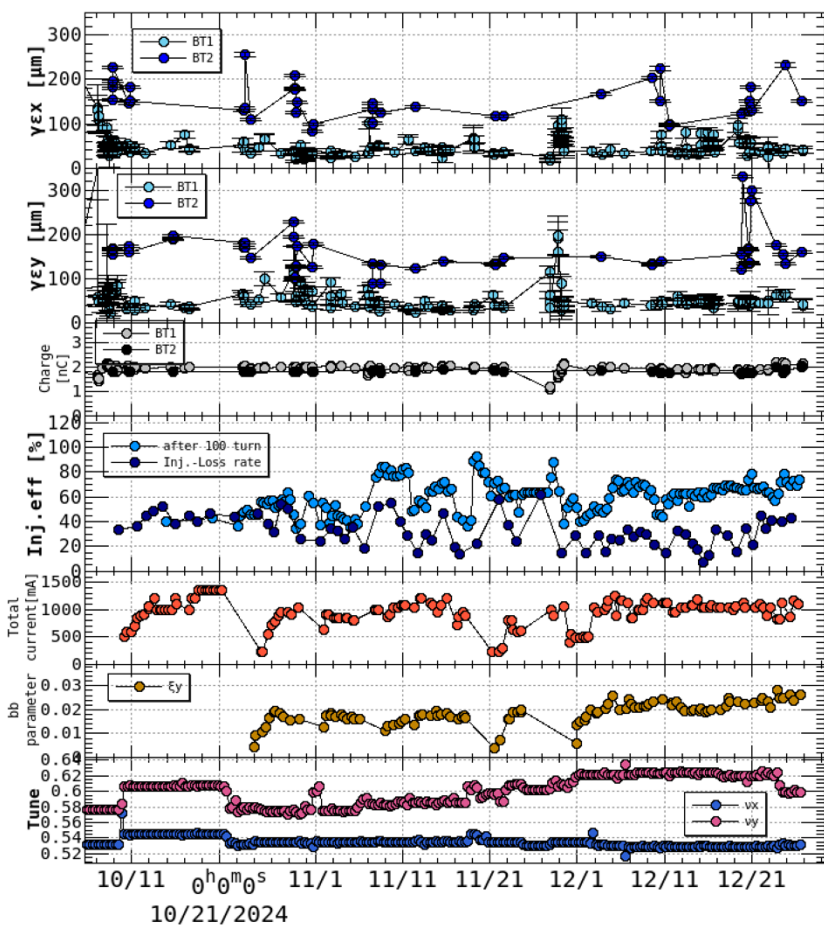

2025c Due to the limited tuning time after the RF replacement, the emittance could not be sufficiently reduced, resulting in poor injection performance throughout the operation.

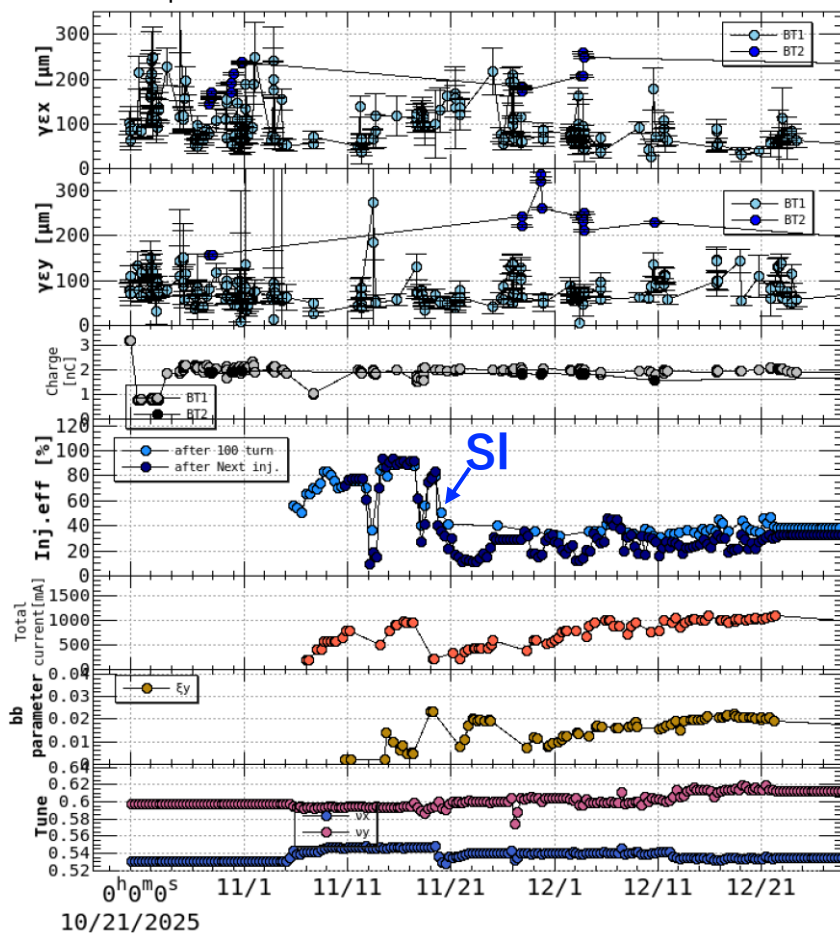

2026ab

$\gamma\epsilon_y$ has been kept smaller thanks to “EAT” (MOP6653).

2 bunch injection

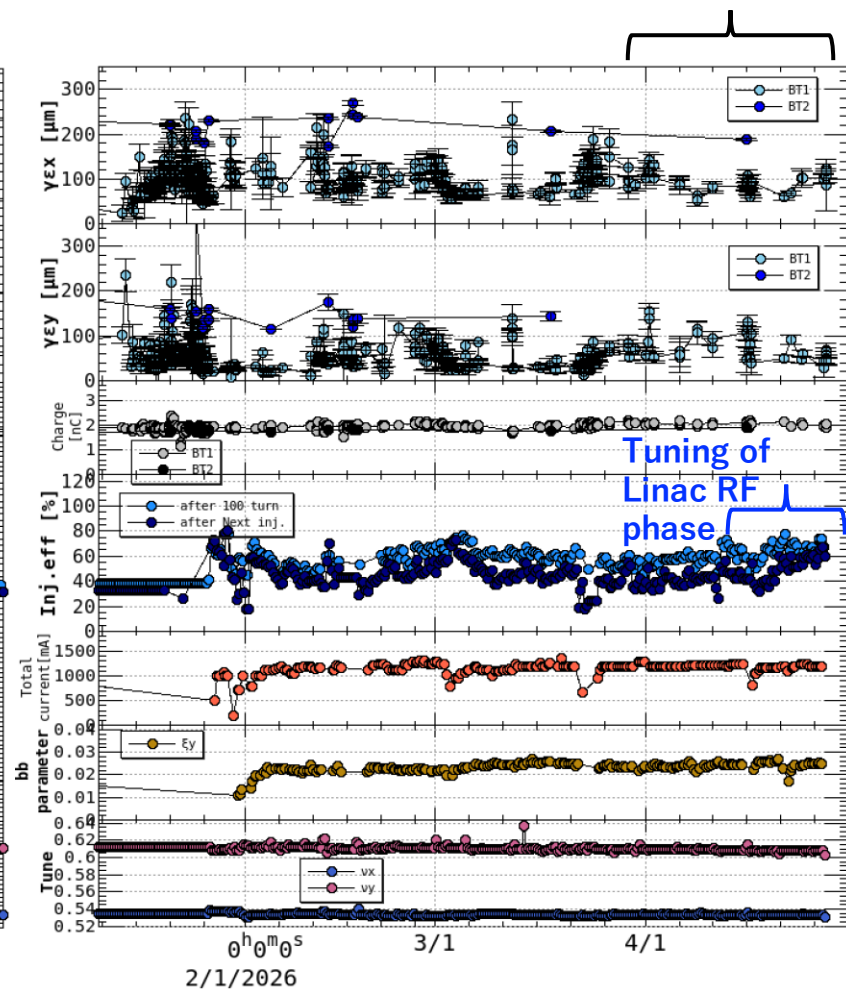

Dynamic aperture measurements

Betatron Injection

Synchrotron Injection

Measured DAs of SI are almost same as those of BI.

Y. Ohnishi

Horizontal amplitude

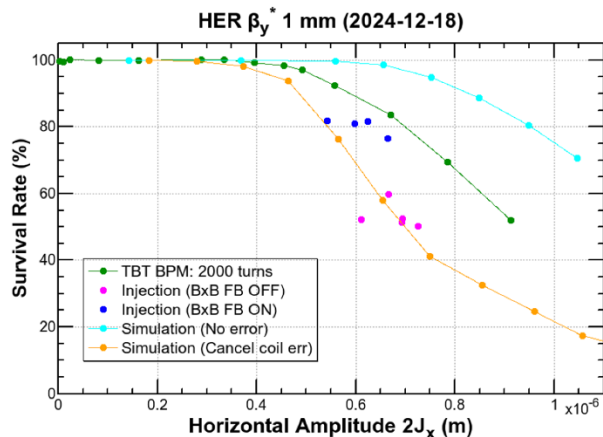

Vertical amplitude

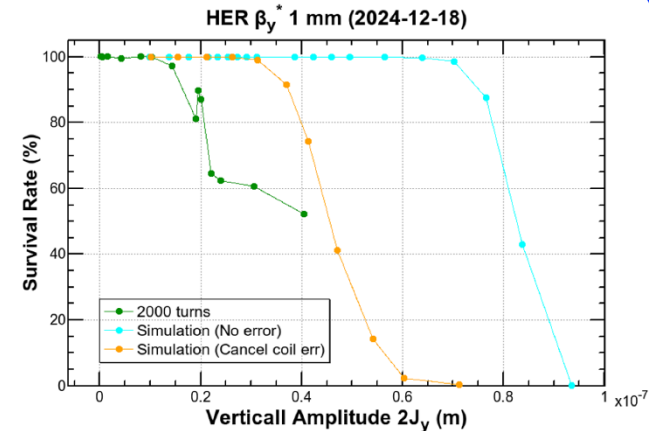

HER β_y^* 1 mm SI optics (2025-11-20)

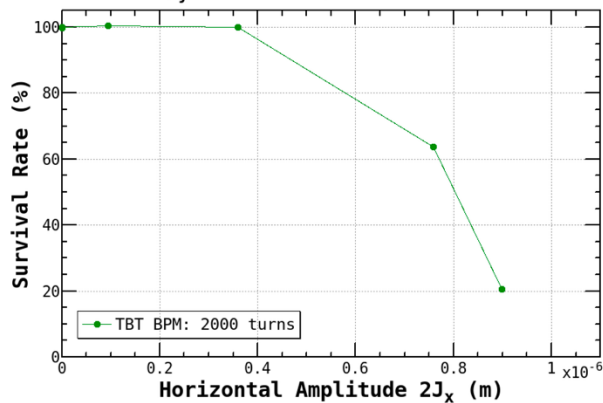

HER β_x^* 60 mm β_y^* 1 mm (2025-11-20)

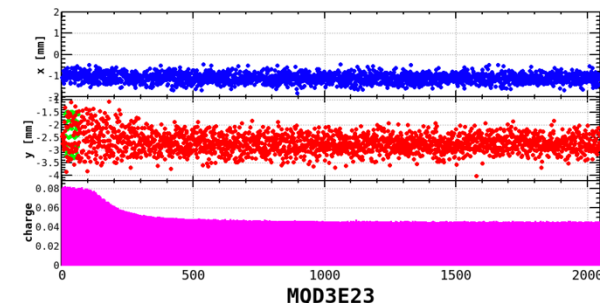
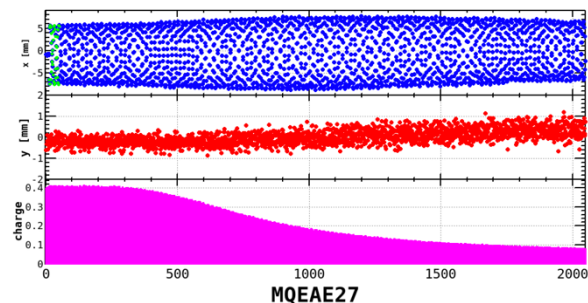
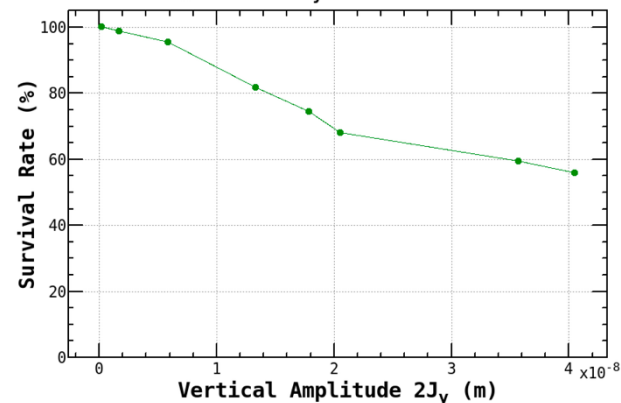

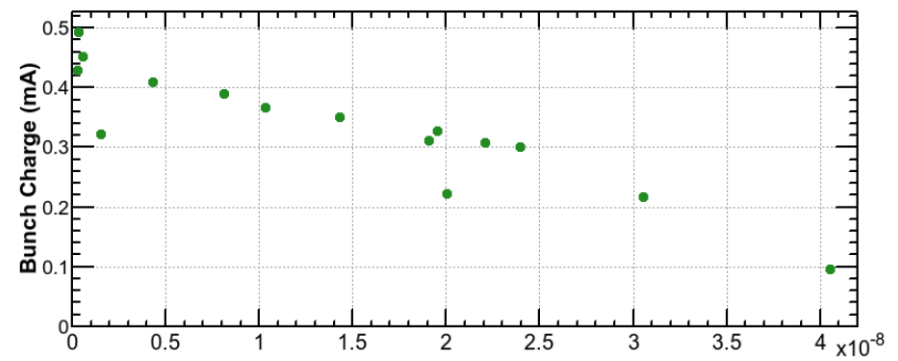
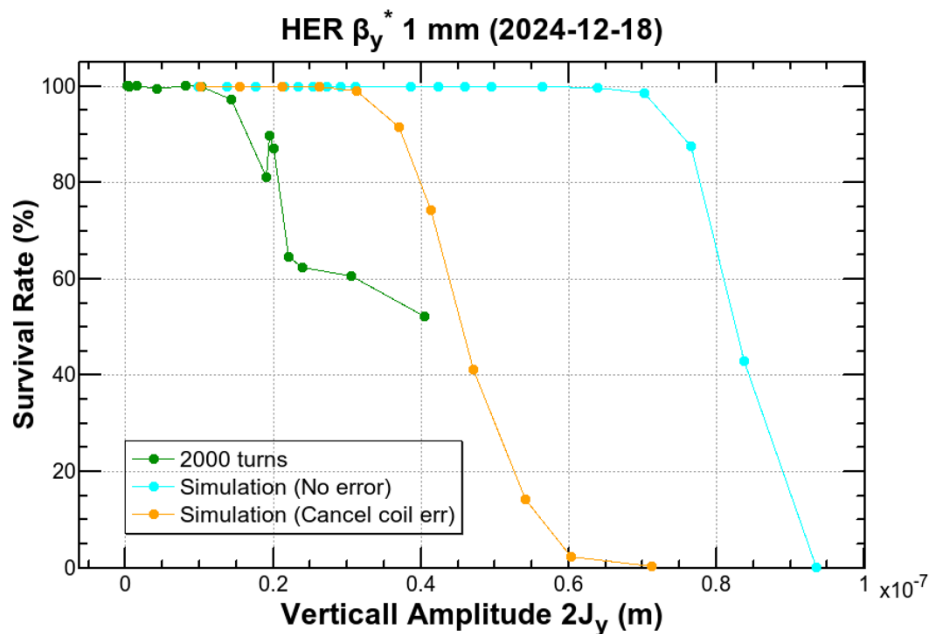
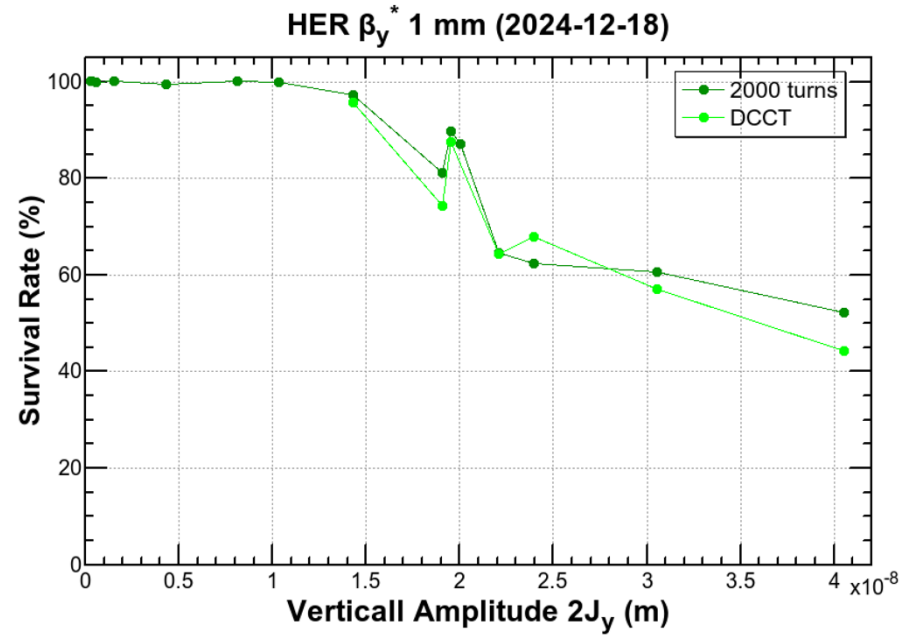
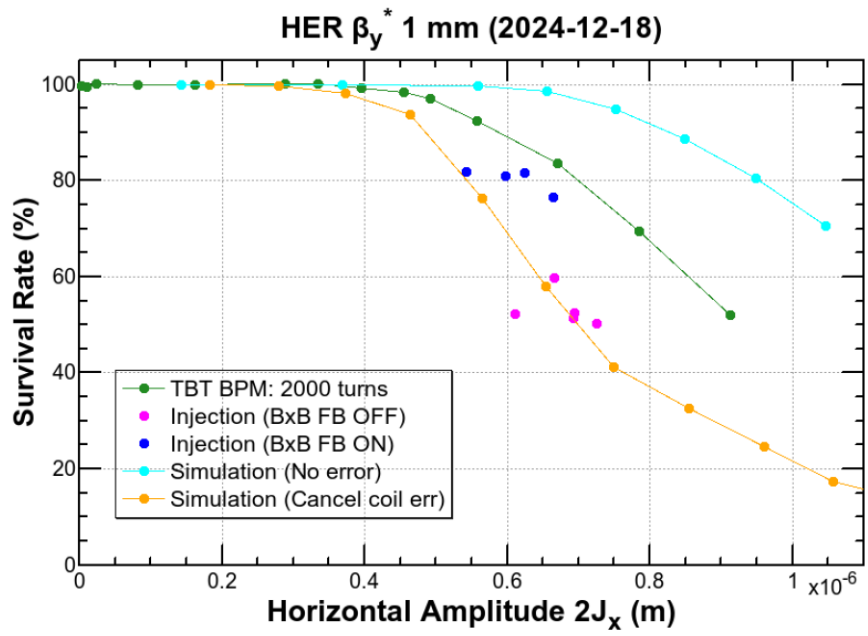

Cancel coil error reduces vertical aperture significantly.

Tracking simulations of the injection to HER

SI: Synchrotron Injection
BI: Betatron Injection
SBI: Synchro-betatron Inj.

K. Oide

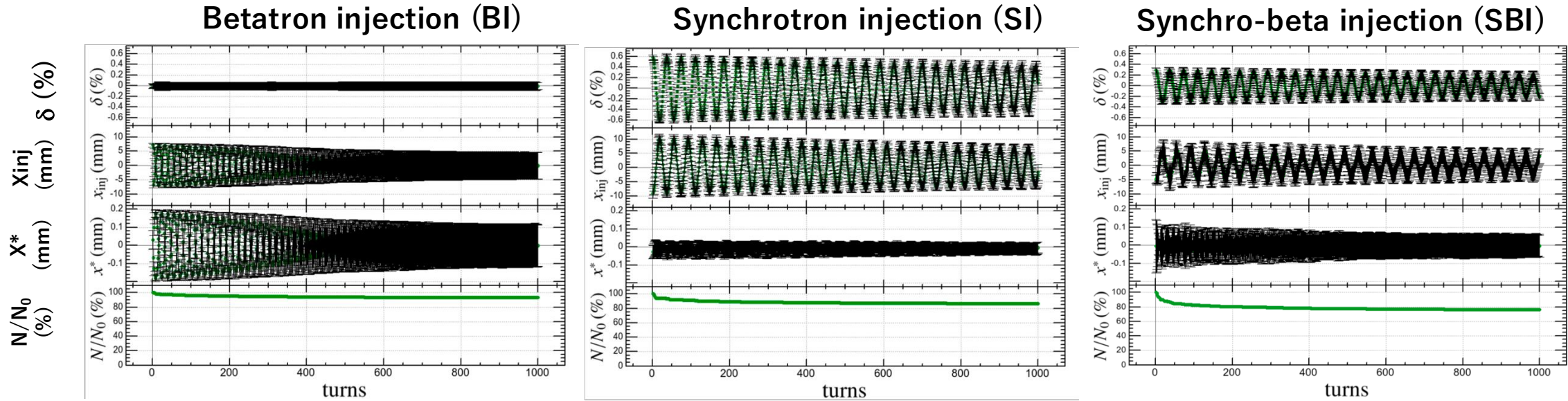

- The horizontal amplitude x_{inj} consists of the synchrotron motion in the case of SI.
- x_{inj} looks smaller for the BI than for the SI.
 - This is because the separation between the stored and injected beams are smaller for the BI. This horizontal displacement at the injection point mostly consists of the synchrotron motion in the case of SI.
- The horizontal oscillation at the IP, x^* , reaches an amplitude of approximately ± 0.2 mm in BI, whereas it is suppressed to less than ± 0.05 mm in SI.
 - This significant reduction in the horizontal injection oscillation suggests that SI provides improved the injection during collision.

	BI	SI	SBI
w/o bb	93.6±0.8	85.6±1.0	77.6 ± 1.3
w bb	91.2±0.8	84.6±1.1	70.9 ± 1.5

- As we did not test SBI.
- For SI, about 5% loss is seen at the first a few turns because that the momentum acceptance is slightly insufficient.

Simulation Injection decay

SI: Synchrotron Injection
BI: Betatron Injection

without
beam-
beam

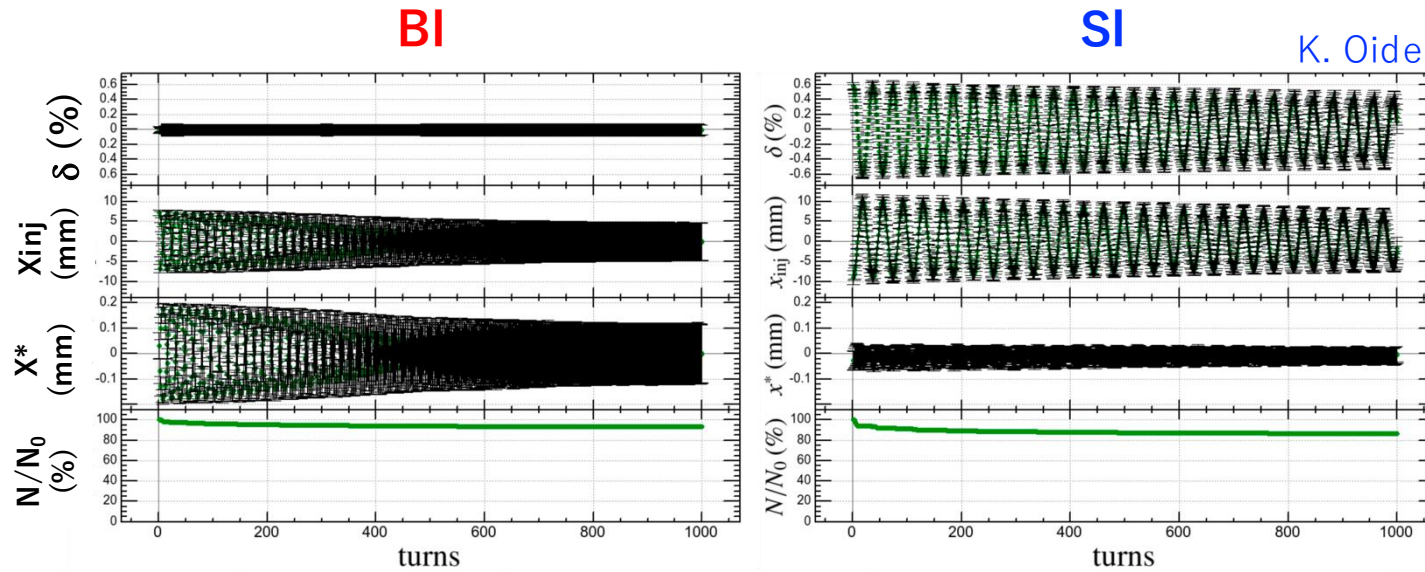

K. Oide

with
beam-
beam

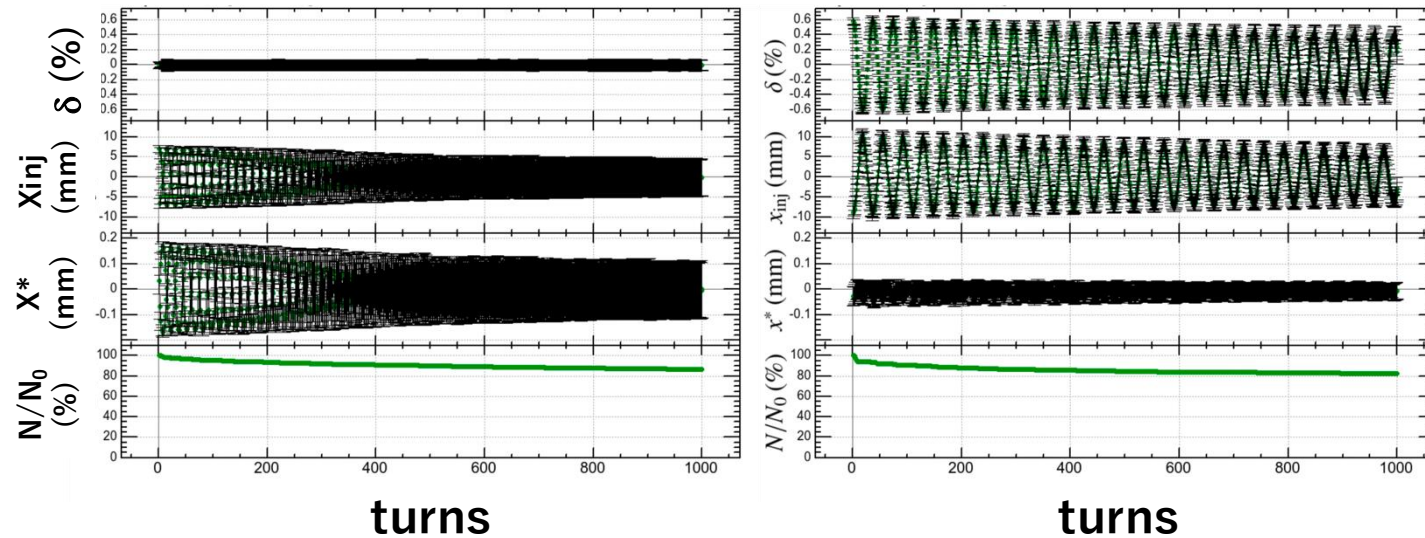

- Behaviors of the injected beam for 1000 turns
- A beam-beam effect
 - $N_{e^+} = 9.04 \times 10^{10}$,
 (4.34×10^{10} for luminosity of $5.24 \times 10^{34} / \text{cm}^2\text{s}$)
- The rows show
 - energy offset
 - horizontal positions at inj.P
 - horizontal positions at IP
 - the ratio of survived particles
- The ring optics
 - $\beta^*_{x,y} = (60, 1) \text{ mm}$.
- The fractional part of the tunes $\{v_{x,y}\} = (0.531, 0.575)$
- The synchrotron tune ν_z
 - 0.027 for w/o b-b
 - 0.028 for w b-b
- The number of injected particles
 - 4000

SI

SI $\beta y^*=0.9\text{mm}$, CW40% w/o cancel coil
DX=7.627mm at PINJAX0

[I] $\eta x=0$ at INJECTIO(BT end)
The dispersion is mis-matched to HER.

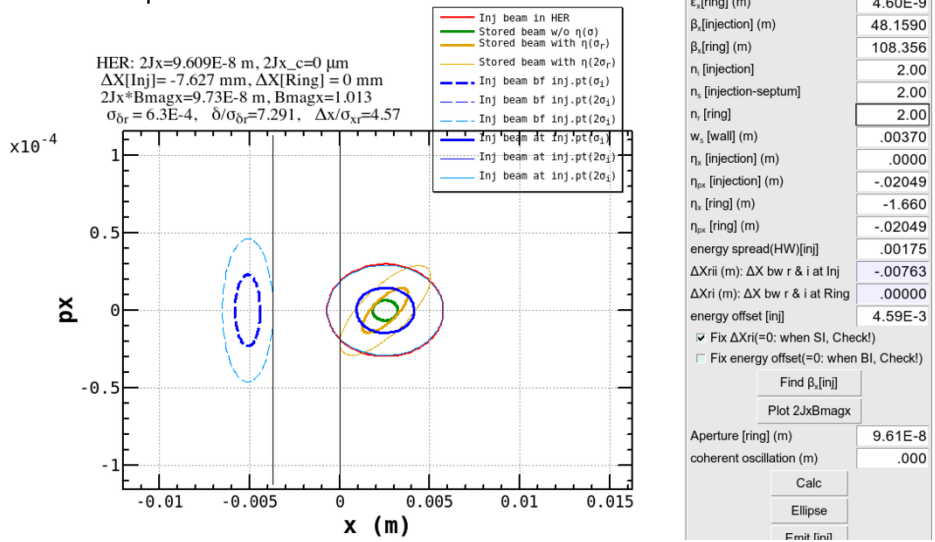

AX	BX	NX	EX	EPX	Element	Length	Value	s (m)	AY	BY	NY	EY	EPY	DetR	#
-3.9132	43.8656	7.90200	3.7E-10	-.02147	INJP	.00000	0	465.254617	.40536	22.2326	5.77424	.00505	1.11E-4	2.E-35	922
4.71E-7	48.1590	7.90462	-.01625	-.02049	PINJAX0	.00000	0	466.020606	-1.5477	22.5219	5.77976	.00524	5.54E-4	2.E-35	927

K. Oide

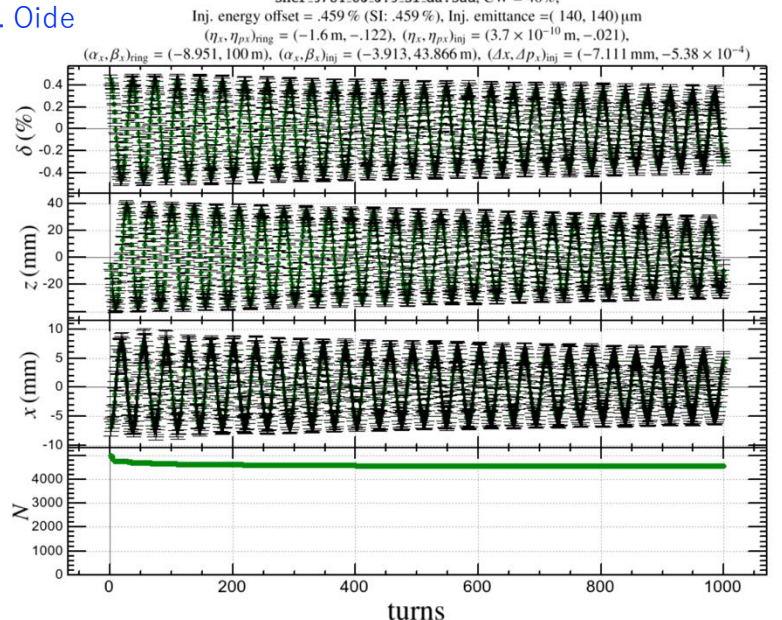

- It is true that the oscillations of both δ and x are smaller when matching is used, and the loss is slightly better when matching is used, but the difference is not significant.
- It is easier to adjust if ηx is closed at the septum exit, so I would like to try SI with both $hx=0$ and 1.6m .

[II] $\eta x=-1.6\text{ m}$ at INJECTIO(BT end)
The dispersion is matched to HER.

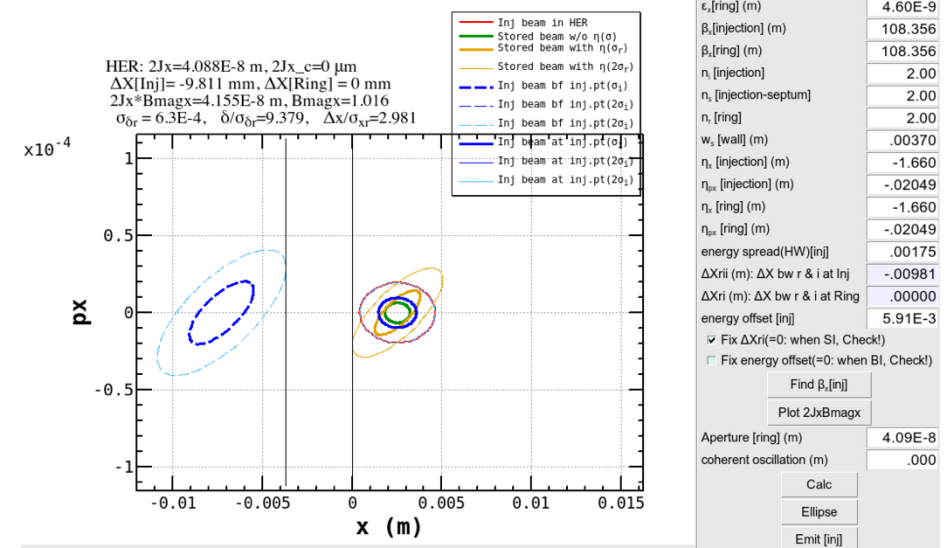

AX	BX	NX	EX	EPX	Element	Length	Value	s (m)	AY	BY	NY	EY	EPY	DetR	#
-8.8324	98.6746	7.90855	1.60000	.12186	INJP	.00000	0	465.254617	.40536	22.2326	5.71179	.00283	2.36E-4	3.E-35	922
-5.5E-9	108.356	7.90971	1.66045	-.02049	PINJAX0	.00000	0	466.020606	-1.5477	22.5219	5.71731	.00307	4.93E-4	3.E-35	927show

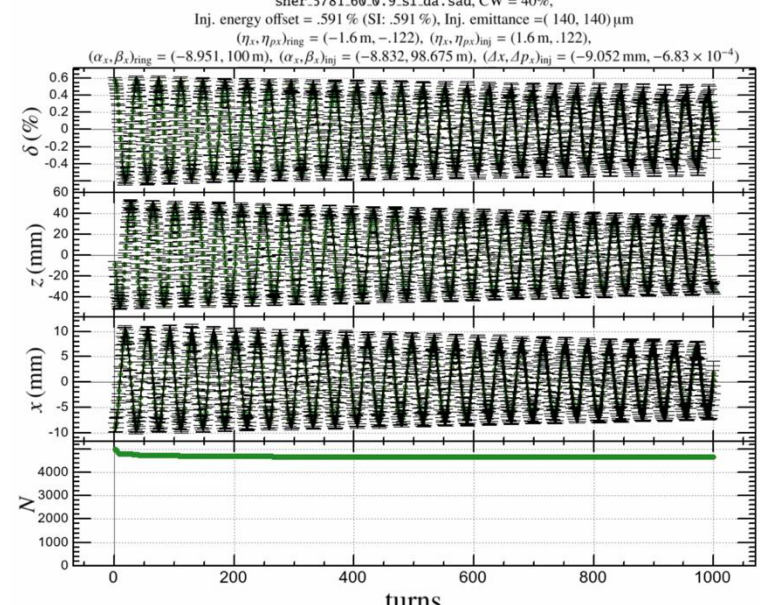

$\beta y^* = 1\text{mm}$ injection tuning

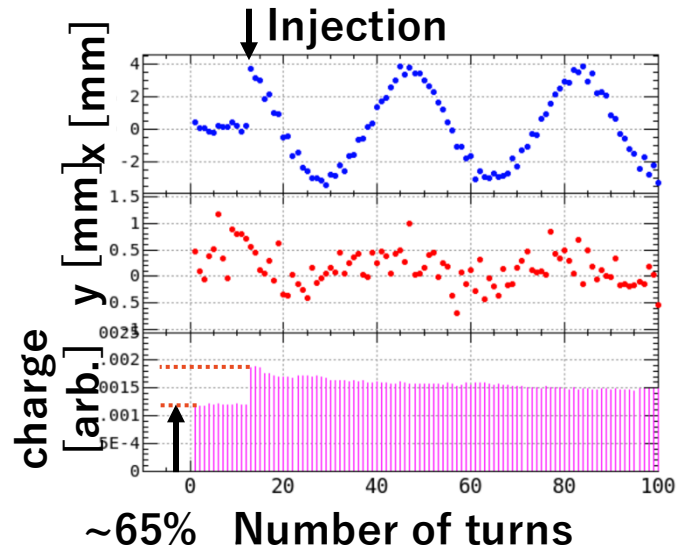

- A TbT-BPM measurement of the injected beam.
- The horizontal axis shows the turn number, where the injection was performed at the turn #12.
- The points before turn #12 show the previously stored beam, which was kicked out by the injection kickers at turn #12, while the next beam is injected simultaneously.
- The stepwise increase in beam charge indicates that the survival ratio of the previously injected beam was 65%, by assuming the same amount of injected charge.
- The injection phase was adjusted so that the horizontal oscillation at a TbT-BPM in a dispersive region is maximized on the first turn.
- This ensures that the longitudinal oscillation arises solely from the energy difference, i.e., the phase is properly tuned.

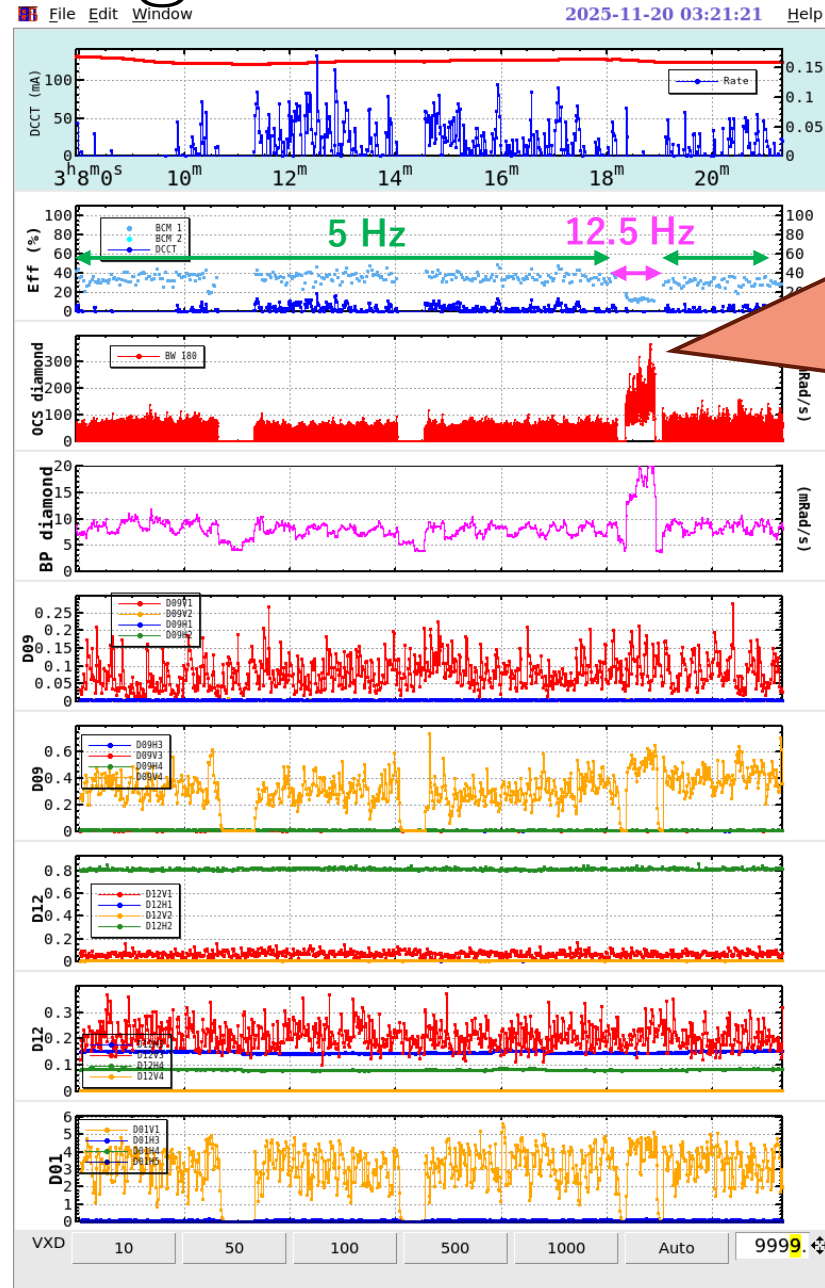

However, for some reason, changing the repetition rate of injection from 5Hz to 12.5Hz reduced the injection efficiency and drastically increased the background (BG) of the Belle II detector.

Injection efficiencies

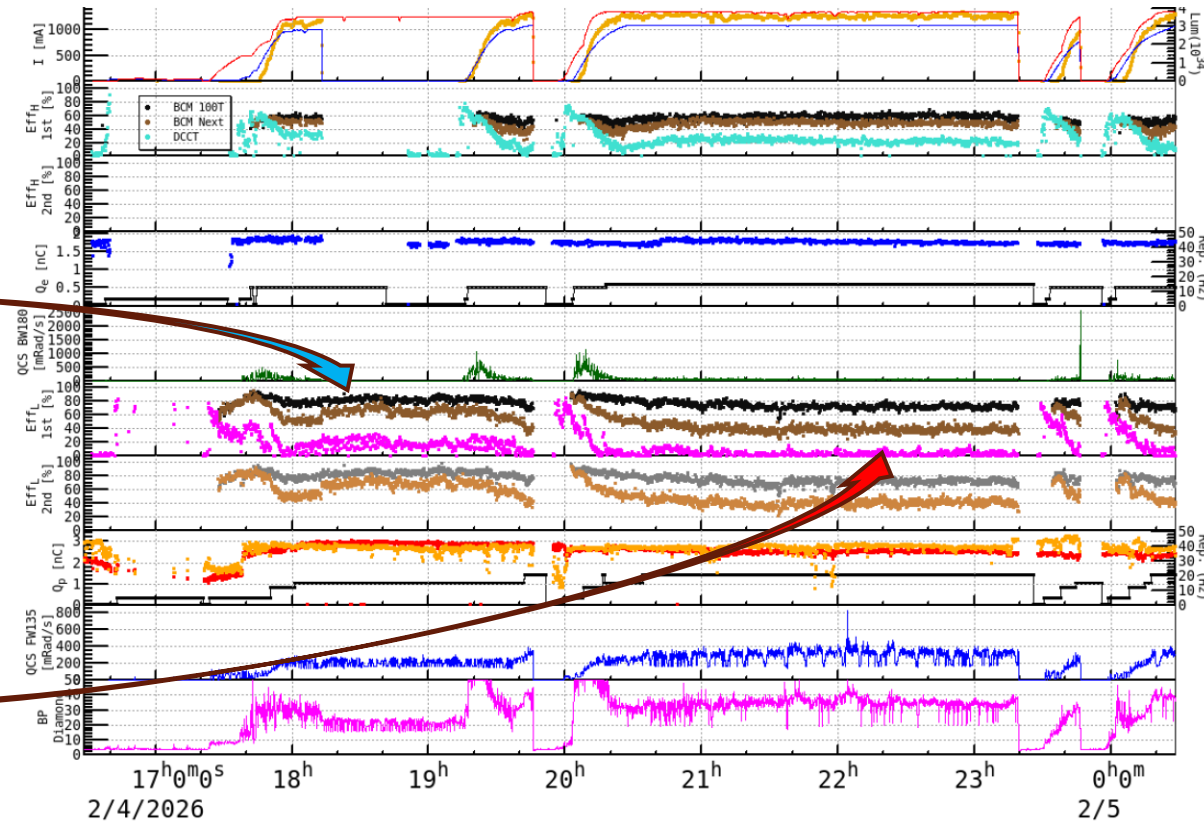
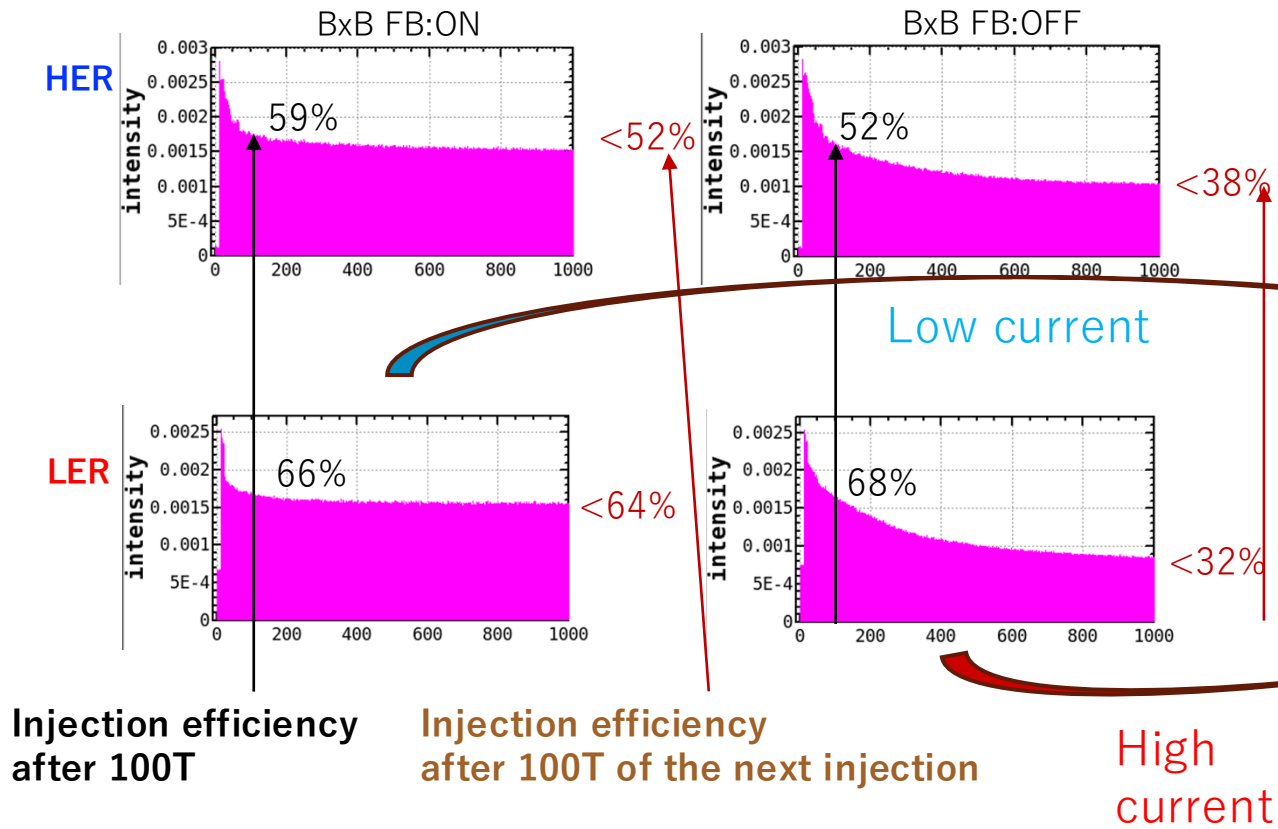

- A) The injection efficiency in the first approximately 100 Turn is easily affected by the effects of the injection beam (injection adjustment, injection beam emittance, etc.).
- B) From 1000 Turn onwards, it is easily affected by the effects of the ring (tuning, beam-beam).