

R&D OF WIDEBAND RF SYSTEM FOR COMPACT MEDICAL PROTON SYNCHROTRON

Z. Fang, K. Endo, K. Egawa, S. Yamanaka, KEK, Tsukuba, Japan
T. Hirashima, T. Fusato, Y. Cho, Denki Kogyo Co., Aikou-gun, Japan

Abstract

The compact proton synchrotron is being developed for the medical radiotherapy. The rf acceleration system is required to be of a wide bandwidth with rf frequency sweeping from 2.0MHz to 17.8MHz during the acceleration time of 5ms and a high gradient with maximal cavity voltage of 10kV. The prototype of the rf system has been developed and the high power test is being performed. The R&D of the rf system and the test results will be presented in detail.

1 INTRODUCTION

The compact proton synchrotron is being developed for the medical radiotherapy [1-2]. According to the lattice design of the machine, the proton synchrotron is operated in pulse mode with the beam acceleration time of 5ms, in which the bending magnet attains 3T and the proton beam energy reaches 200MeV [3-5]. The circumference of synchrotron is only 9.54m, so the beam acceleration system is required to have frequency sweeping from 2MHz to 17.8MHz, and maximal rf cavity voltage of 10kV, as shown in Fig. 1. Therefore, the key features of this rf system are the relatively wide bandwidth and the high acceleration gradient. The rf system has been designed and developed as shown in Fig. 2, and the above requirements have been successfully achieved.

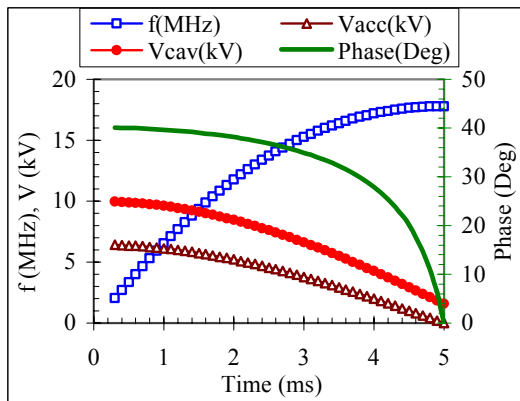

Figure 1: Required rf frequency, beam accelerating voltage, cavity voltage, and acceleration rf phase, as functions of acceleration time.

2 RF CAVITY

The rf cavity consists of 2 cells with gap located in the center of each cell, and the 2 cells of rf cavity are driven by a push-pull power amplifier in parallel. There are 4 high-permeability magnetic alloy cores loaded in each cell, and the cavity length is 400mm. The impedances at the two gaps have been measured. The average value of

impedances of test results and the calculation results are shown in Fig. 3. It is shown that the test results agree with the calculation results very well. The gap capacitance is about 24pF, and the complex permeability of cores is $\mu = 1288f^{-0.81} - j3161f^{-0.81}$, where f is in MHz.



Figure 2: RF cavity and power amplifier.

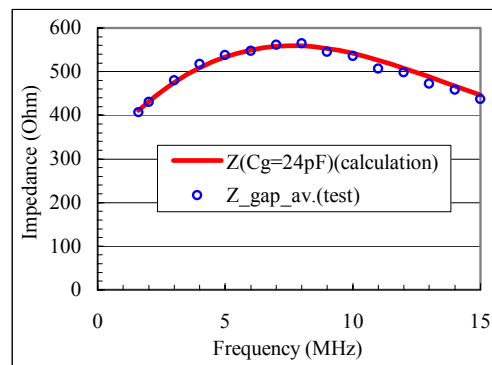

a) Impedance amplitude

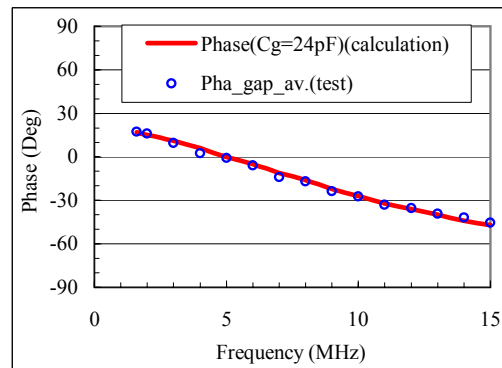

b) Impedance phase

Figure 3: Test and calculation results of cavity gap impedance.

3 POWER AMPLIFIER

In the rf system, two tetrode tubes 4CX35,000C are used to form a push-pull amplifier to drive the two cells of rf cavity in parallel, as shown in Fig. 4. Each side of the cavity gaps is directly connected to the anodes of the two tubes through the DC blocking capacitors of 0.1 μ F.

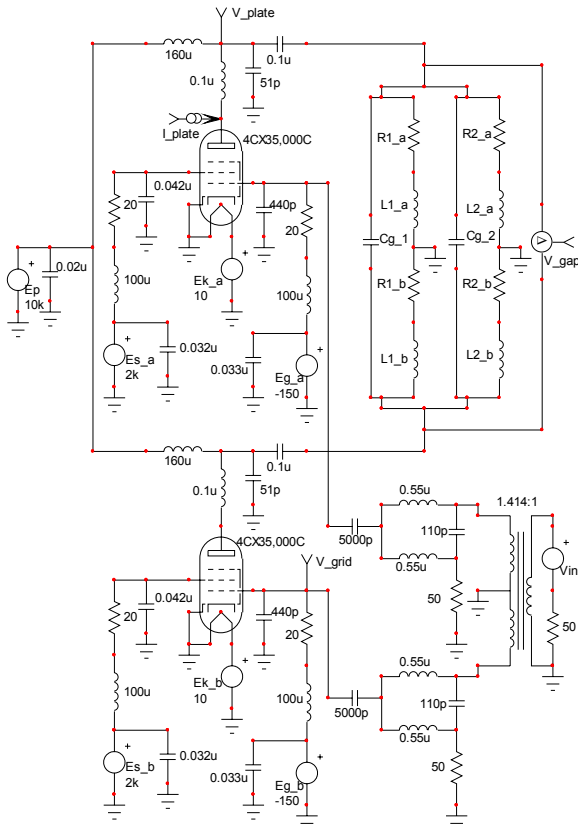

Figure 4: Circuit of rf system.

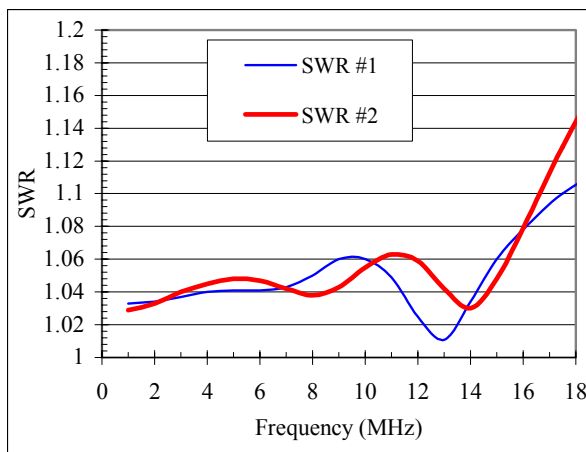

Figure 5: SWR of two input matching circuits for tubes.

The input and output capacitances of the tube are 440pF and 51pF, respectively. All-pass network is applied to the input circuit for matching the tube's input capacitance [6]. The parts of the all-pass network have been adjusted carefully, and the SWR of tube input circuit

is obtained smaller than 1.15 in the whole operation frequency range, as shown in Fig. 5. A 2kW preamplifier is used to drive the main amplifier.

4 HIGH POWER TEST

We have taken the data of input power for getting the required gap voltage. Since there are 2 gaps in the rf cavity, the required gap voltage is half of the summation. Thus the maximal required gap voltage is 5kV. Fig. 6 shows the experiment results. From the test results, we can see that the rf system can successfully produce the required gap voltage.

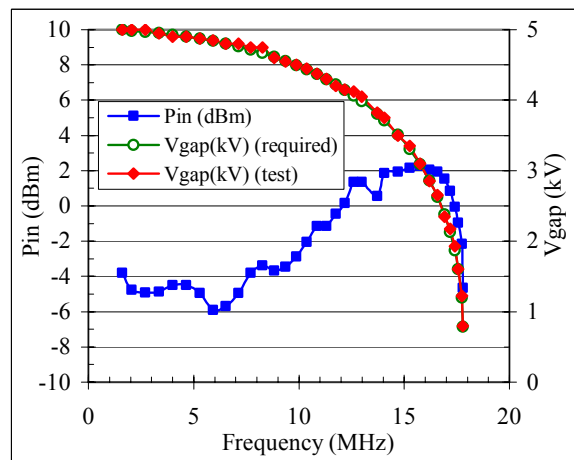

Figure 6: Input power for getting required gap voltage.

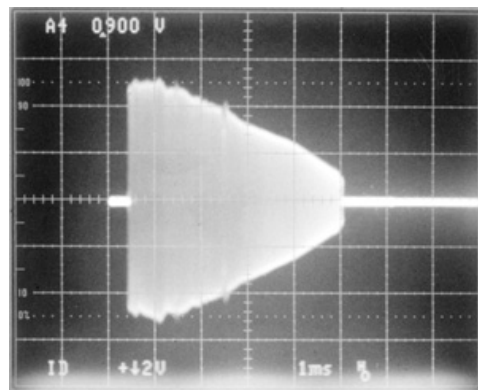

Figure 7: Waveform of gap voltage with rf frequency sweeping from 2.0MHz to 17.8MHz and amplitude envelope of $5\cos(90\pi t)$ kV.

The above data of the input power for obtaining the required gap voltage is used as the initial input data of the rf control system based on a DDS signal generator. The high power test with the rf control system has been performed with feedback off, and a waveform of gap voltage with rf frequency sweeping from 2.0MHz to 17.8MHz and amplitude envelope of $5\cos(90\pi t)$ kV has been successfully obtained, as shown in Fig. 7. Soon we will do more experiments carefully to carry out the waveform clearer.

Also we have taken the data of maximal gap voltage produced by the rf system. The test results of maximal

gap voltage and its ratio to the required gap voltage are shown in the curves with $L_i=0$ in Fig. 8 and Fig. 9. It shows that from 13MHz to 17MHz, almost no margin exists between the maximal voltage and the required voltage.

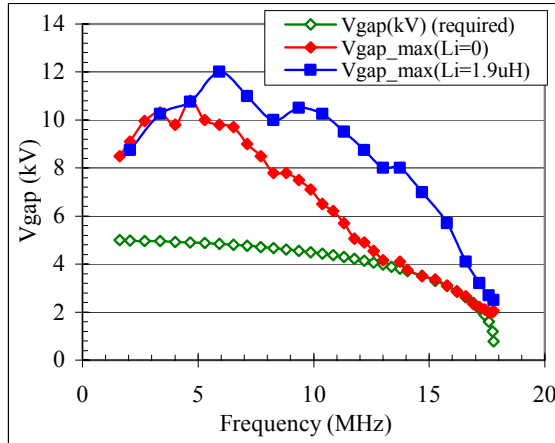

Figure 8: Obtained maximal gap voltage as function of frequency.

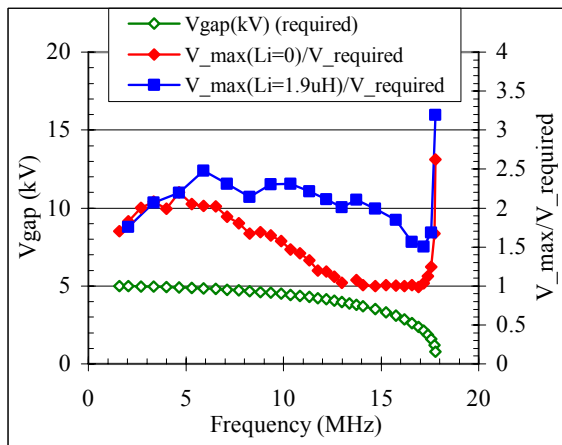

Figure 9: Ratio of obtained maximal gap voltage to the required gap voltage as function of frequency.

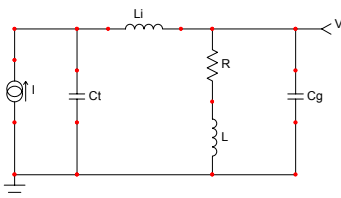

Figure 10: Equivalent circuit with an inductor inserted between the cavity and amplifier tube.

In order to improve the frequency response of rf system, an inductor (L_i) of 1.9 μ H is inserted between the cavity and amplifier tube, as shown in Fig. 10. In this case, the ratio of cavity voltage to rf current becomes:

$$\frac{|V|}{|I|} = \sqrt{\frac{R^2 + \omega^2 L^2}{[1 - \omega^2 LC - \omega^2 C_t L_i (1 - \omega^2 LC_g)]^2 + [\omega R (C - \omega^2 C_g C_t L_i)]^2}}$$

where $C = C_t + C_g$. And the formula shows that the frequency response of rf system will be improved by inserting a small inductor (L_i). We have taken the data of maximal gap voltage again, and the test results are shown in the curves with $L_i=1.9\mu\text{H}$ in Fig. 8 and Fig. 9. The above experiments show that the performance of the rf system is successfully improved, exactly agreeing with the calculation results. Now a relatively wide band rf system has been carried out with much higher cavity voltage than required in the whole operation frequency range. Fig. 11 shows the obtained maximal acceleration gradient as function of frequency. The maximal gradient reaches 60kV/m at 5.91MHz.

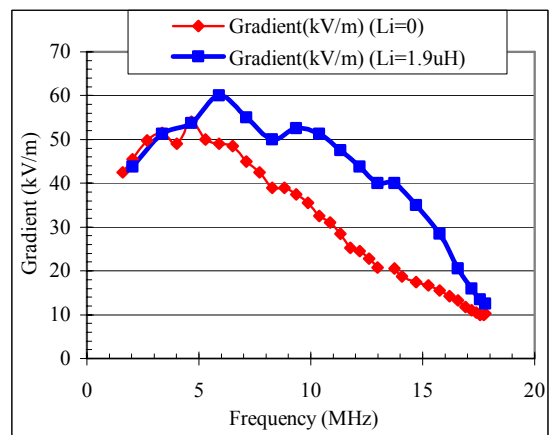

Figure 11: Obtained maximal acceleration gradient as function of frequency.

5 SUMMARY

The rf system for the compact proton synchrotron has been developed. And the high power test has been successfully performed to achieve the required gap voltage. More tests of the rf system with the low-level control system will be performed.

REFERENCES

- [1] K. Endo et al, "Compact Proton and Carbon Ion Synchrotrons for Radiation Therapy", EPAC 2002, 2733-2735, France.
- [2] K. Endo et al, "Development of High Field Dipole and High Current Pulse Power Supply for Compact Proton Synchrotron", PAC 2003, 1071-1073, USA.
- [3] K. Endo et al, "Development of Compact Proton Synchrotron for Radiation Therapy", ARTA 2003, 51-54, Japan.
- [4] K. Endo et al, "High Field Pulse Dipole and Quadrupole Magnets for Compact Medical Pulse Synchrotron", APAC 2004, Korea.
- [5] K. Endo et al, "Compact Synchrotron for Radiotherapy Based on Pulse Technology", ARTA 2004, 7-10, Japan.
- [6] Z. Fang et al, "Test Results of RF Cavity and Power Amplifier for Compact Medical Proton Synchrotron", APAC 2004, Korea.