

EFFECTS OF GAPS AT LONGITUDINAL VANE JOINTS ON RFQ FIELD

N. Ueda, T. Nakanishi
Institute for Nuclear Study, University of Tokyo
Midori-cho, Tanashi, Tokyo 188, Japan
and

K. Inoue
Tsurumi Works, Toshiba Corporation
Suehiro-cho, Tsurumi-ku, Yokohama 230, Japan

Summary

Effects of gaps at longitudinal vane joints on the RFQ field were studied by using a model cavity of four vane structure. The model consists of two cavities joined with a ring spacer between their outer conductors. With gap width of 0.1 to 2 mm, field distribution, resonant frequency and Q value were measured for TE₂₁₀ mode. The resonant frequency was 296.5 MHz. The shift was within 30 kHz namely 0.01 percent. Significant effect on the field distribution was not observed. The Q value was 4000 for no spacer, and 3600 for 2 mm spacer.

Introduction

On a construction of a long RFQ linac, for example, 7 m long, the vanes should be made by connecting several sections, because it is very difficult to make the vanes in a piece. Considering assembly procedure and transportation, it is practical to make the RFQ by connecting several four vane cavities each of which is assembled separately. At the joints it is desirable to make gaps between the vanes, in order to tolerate machining errors and unequal thermal elongation. The gaps, however, may lower Q value, give a jump to the vane voltage and enhance surface electric field strength around the gaps. Then effects of the gaps on the RFQ field were studied.

Model Cavity

The cavity is made by connecting two sections (Figs.1,2). They are joined with a ring shaped copper spacer of various thickness between the cylinders. Each section has an inner diameter of 258 mm and a length of 490 mm. The cylinders are made of copper plated mild steel. The vanes were made by separating the straight vanes of the INS RFQ cold model-2¹⁾. The vanes are made of pure copper. Each has a thickness of 35 mm and 470 mm length. The vanes are mounted to the cylinder by using fixing flanges. The rf contact is assured with copper braid having rubber string inside. The vane top is approximated by a circular arc of 14.3 mm radius and tangential lines. The aperture radius r_0 is 14.3 mm. Both sides of the cavity are covered with end flanges made of aluminum alloy. The distance between the vane end and the flange is 20 mm.

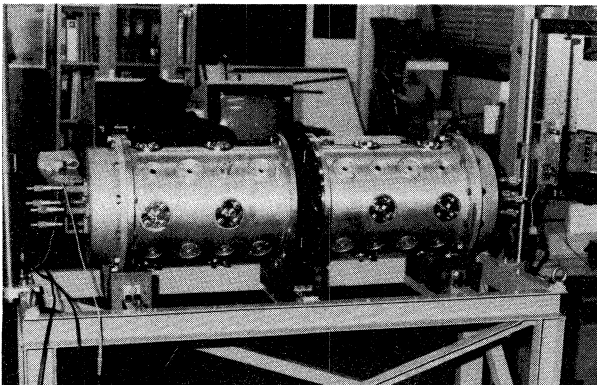

Fig.1. View of the model cavity.

On each end flanges four capacitive tuners are mounted. The tuner is a copper rod of 25 mm in diameter. On the cylinder wall there are 32 holes of 14 mm dia. for a perturbing metal block, rf feed and pickup. The cavity is excited with a loop. The resonant frequency of TE₂₁₀ mode was predicted at 296.5 MHz with SUPERFISH calculation.

The vanes are assembled within an error of 0.1 mm in the transverse plane. With no spacer there is clearance below 0.1 mm between the vanes owing to machining and assembly errors.

Field Measurement

Experimental setup

The field strength was measured with perturbation method. It is well known that the resonant frequency shift due to a perturbation is proportional to the square of the field strength at the perturber position. On this experiment a shift of the phase difference between the input and pickup signals was measured with a vector voltmeter. The phase shift is proportional to the resonant frequency shift when the perturbation is small. On resonance, the electric length of the rf pick up cable was adjusted to give no phase difference between the input and pickup signals. An analog output which is proportional to the phase difference was recorded on a strip chart or read by a desktop computer through a GP-IB digital voltmeter.

A brass rod was inserted from side holes to measure the magnetic field. Aluminum perturbing balls of 2 mm and 6 mm in diameter were used to measure the electric field around the vane tops.

TE₂₁₀ mode

With no spacer, the end tuners were adjusted to give uniform field within a few percent error. The measured resonant frequency was 296.5 MHz for the TE₂₁₀ mode. Then the field distribution, Q value and resonant frequency shift were measured for spacers with thickness of 0.2 to 2 mm without retuning the end tuners.

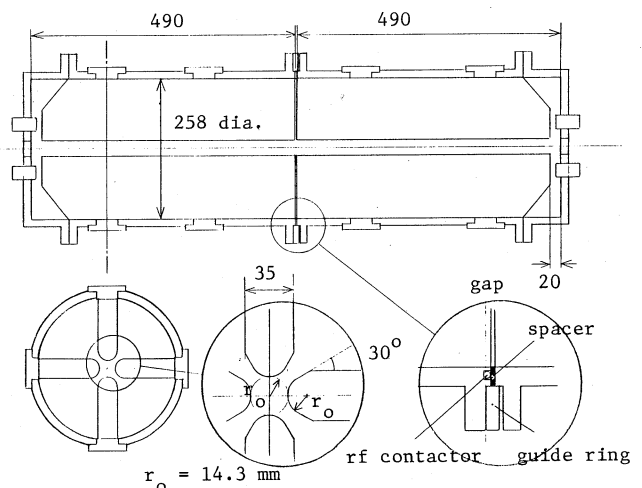

Fig.2. Schematic drawing of the model cavity. Dimensions are in mm.

The magnetic field distributions are shown for no spacer and 2 mm spacer (Fig.3). The azimuthal distribution varied slightly, but it can be recovered easily. The electric field distribution between the vanes with 2 mm spacer is shown in Fig.5. Serious effect of the gaps on the distribution was not observed. The resonant frequency varies only within 30 kHz namely 0.01 percent. The Q value lowered from 4000 for no spacer to 3600 for 2 mm spacer. The electric field distribution very near the vane tops is shown in Fig.4. A depression of 12 percent was observed at the center, but no enhancement was detected around the gaps.

Quadrupole field tilted along the axis

In order to estimate the vane voltage jump when the electric field is not uniform along the axis, a quadrupole field of tilted distribution was excited. The end tuners on one end were touched to the vanes and ones on another end were set 20 to 7 mm apart from the vanes to give azimuthally uniform field. The end tuning gives the steepest field distribution.

In Fig.6 the electric field between the vanes is shown for no spacer, 0.1 mm and 2 mm spacer. Jumps of the intervane field, Q value and resonant frequency shift for spacers of various thickness are shown in Fig.7. The ratio of the jump to the maximum field strength is 16 percent in phase shift, namely, 8 percent in electric field for 2 mm spacer.

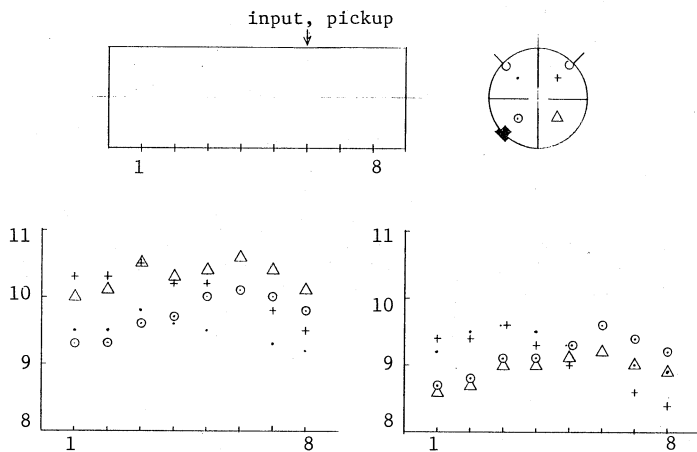

Fig.3. Magnetic field distribution measured with a perturbing rod inserted through side holes. Vertical axis is phase shift (deg.). Left : no spacer. Right : 2 mm spacer.

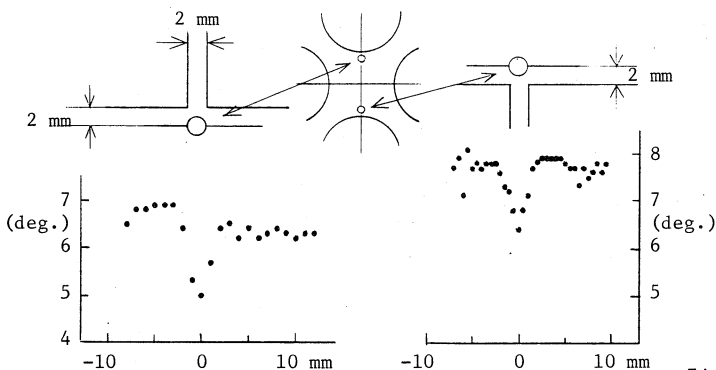

Fig.4. Field distribution near the vane tops. The perturbing ball diameter is 2 mm. Vertical axis is phase shift (deg.).

Conclusion

It was confirmed that gaps below 2 mm do not give serious effect on the RFQ field. In this model the aperture radius of the vane tops is 14.3 mm and considerably larger than a radius of a real RFQ which will have a radius around 5 mm. By assuming that the effect of the gap can be scaled in a ratio of gap to aperture radius, the 2 mm gap is equivalent to 0.7 mm on a real machine. It is not difficult to control the gap width below this value on manufacturing of the machine.

Beam loss due to alignment error of the beam axis at the joints and enhancement of surface field near the gaps are discussed in another paper.²⁾

Acknowledgement

The authors express their thanks to Mr. S. Itoh, Tsurumi Works, Toshiba Corporation, who supported the manufacturing of the model cavity. They also thanks to S. Watanabe who helped us on the experimental setup. They are grateful to S. Yamada for helpful discussion.

References

- 1) T. Nakanishi et al., INS Report NUMA-30 (1982).
- 2) T. Nakanishi et al., contributed to this symposium.

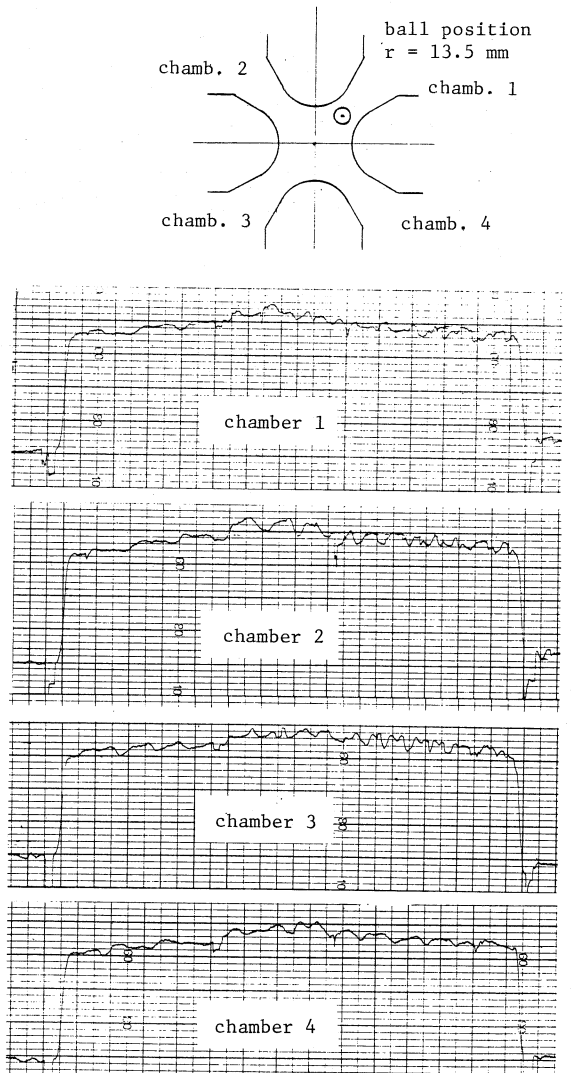
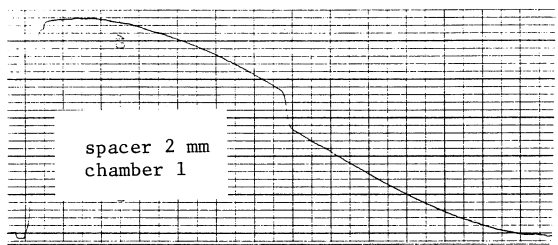
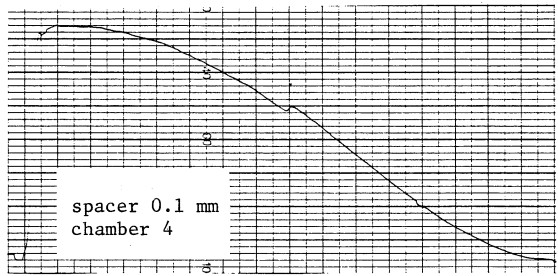
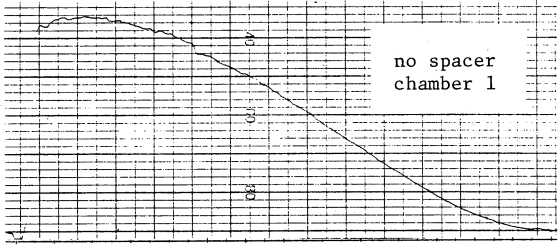

Fig.5. Electric field distribution between the adjacent vanes with 2 mm spacer. The perturbing ball is 2 mm in diameter. Vertical axis is phase shift (arbitrary scale).



open end

short end

Fig.6. Field distribution of a quadrupole field tilted along the axis. The perturbing ball diameter is 6 mm. The ball position is the same as Fig.4. Vertical axis is phase shift (arbitrary scale).

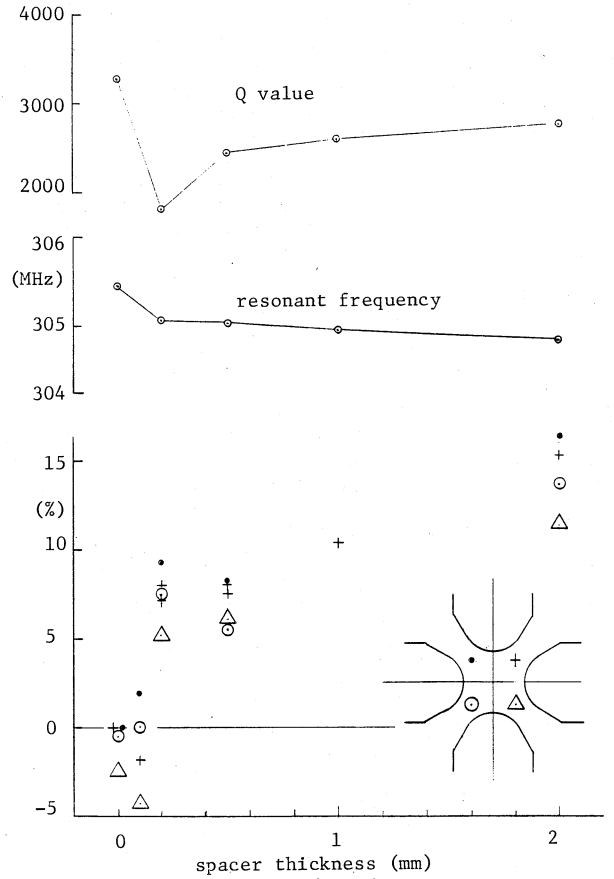

Fig.7. Q values, resonant frequency and jump of the intervane field vs. spacer thickness for the tilted mode. The jump of the phase shift is shown in the ratio to the shift of the maximum field (percent).