

2p2-4

Study on Tuning-Free Network for RF Accelerating Cavity

M.Yamamoto¹, T.Rizawa², T.Saito¹, H.Tamura¹, M.Uraki¹, Y.Morii², K.Hosono¹,
K.Hatanaka¹, T.Itahashi¹, K.Takahisa¹, K.Tamura¹, I.Miura¹, and K.Sato¹

¹Research Center for Nuclear Physics, Osaka Univ., 10-1, Mihogaoka, Ibaraki-shi, Osaka 567, Japan

²Toshiba Corporation, Heavy Apparatus Engineering Lab.

2-4, Suehiro-cho, Tsurumi-ku, Yokohama-shi, Kanagawa 230, Japan

abstract

Applying a bridged-T type all-pass network to a resonator described as a parallel circuit, the output voltage of the resonator shows a band-pass feature over a certain frequency range, while the input impedance is always constant against frequency. This feature is considered to realize the ferrite-loaded tuning-free RF accelerating cavity. It has several merits such as a simple cavity structure without bias windings, an easy operation without feedback control of the bias current, applying new ferrite with favorable RF characteristics and so on.

1. Introduction

A ferrite-loaded RF cavity for an RF system of a synchrotron produces, in general, the accelerating voltage at its resonance frequency, which is synchronized with the revolution frequency by bias field. On the other hand, applying a bridged-T type all-pass network to a cavity regarded as a parallel resonance circuit, accelerating voltage shows a band-pass feature without bias field.

The accelerating cavity as above can be energized by a commercial transistor RF power amplifier because the input impedance of the network with a terminating resistor is always equal to one of the resistor, i.e. always constant against frequency.

A rough estimation of behaviors of the all-pass cavity circuit has performed, based on RF characteristics of new ferrite material under development. It shows that an RF accelerating voltage of 630 V over the frequency range from 1 MHz to 8 MHz can be achieved in a 60 cm long cavity by a 1 kW RF power amplifier. This type of accelerating cavity is applicable to a proton-synchrotron for radio therapy and a cooler-synchrotron in multi-GeV region.

2. A bridged-T type all-pass network

As shown in fig.1, a bridged-T type circuit consists of three impedances, Z_1 , Z_2 and Z_3 , and is terminated in a resistor R . In this circuit, the all-pass conditions that the input impedance is always constant value R are,

$$Z_2 = \frac{R^2}{2Z_1}, \quad Z_3 = 4Z_1 \quad (1)$$

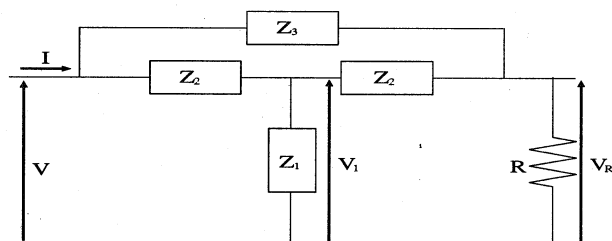

Figure 1: A bridged-T type all-pass network with a terminating resistor R .

In general, a lumped constant circuit of an accelerating cavity is shown as a parallel resonance circuit with a self-inductance, a capacitance and a resistance caused by RF power loss of ferrite. However, an equivalent circuit of a cavity is approximately equal to a parallel circuit that Z_1 consists of L_1 and C_1 as shown in fig.2, because the RF power loss of new ferrite is far less than the former one, as discussed in the next section, and also because the terminating resistor exists.

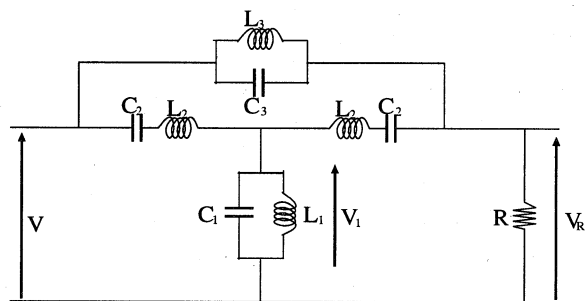

Figure 2: A bridged-T type circuit regarding an accelerating cavity as a parallel resonance circuit.

From the all-pass conditions of eq.(1), Z_2 should be a series circuit of L_2 and C_2 , Z_3 should be a parallel circuit of L_3 and C_3 . They should satisfy the following conditions respectively in any resonance frequency;

$$C_2 = \frac{2L_1}{R^2}, \quad L_2 = \frac{C_1 R^2}{2}, \quad C_3 = \frac{C_1}{4}, \quad L_3 = 4L_1 \quad (2)$$

When these conditions are satisfied, the ratio of the input voltage V to the input current I is constant as R against frequency, that is, an all-pass feature appears. As for the voltage V_R between both ends of the terminating resistor, $|V_R/V| = 1$ is satisfied

at all frequencies. Then the voltage V_1 that appears between ends of the parallel resonant circuit of L_1 and C_1 has band-pass characteristics, as shown in fig.3. $|V_1/V| = 1$ is satisfied at frequencies ω_l and ω_u , and V_1 exceeds the input voltage between them, which satisfy

$$\omega_l \omega_u = \omega_0^2 \quad (3)$$

where ω_0 is a resonance frequency. The purpose of this study is to apply the band-pass characteristics like fig.3 to an accelerating cavity.

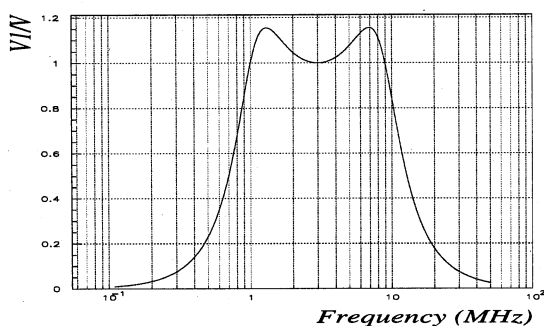

Figure 3: The frequency dependence of $|V_1/V|$. The voltage V_1 between both ends of a parallel resonant circuit of L_1 and C_1 has band-pass characteristics.

Let N be the ratio ω_u/ω_l , then N is given as the expression with the terminating resistor R and the characteristic impedance of the resonant circuit.

$$N = \frac{\omega_u}{\omega_l} = \left(\sqrt{1 + \frac{1}{R^2} \frac{L_1}{C_1}} + \frac{1}{R} \sqrt{\frac{L_1}{C_1}} \right)^2 \quad (4)$$

From eq.(4), a wider frequency range can be realized by increasing a characteristic impedance or decreasing a terminating resistor R .

3. Development of new ferrite

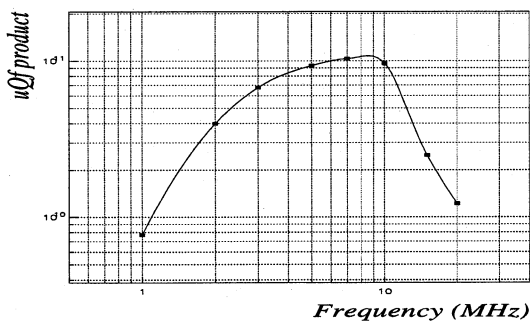

Figure 4: A frequency dependence example for μQf product of new ferrite developed.

Since there is no bias field on ferrite of a cavity in this circuit, new type ferrite material can be applied. NiZn has been used for the cavity because of quick response to the bias field. However, it is not necessary

in this circuit and the ferrite containing Co can be used. Accordingly RF power loss can be reduced.

Now, Such material of the ferrite, which RF power loss has minimum value around 4 MHz, has been developed, supposed that this cavity is used over the frequency range 1-8 MHz. From the preliminary data until now, the frequency dependence for μQf product of the ferrite recently developed is shown in fig.4. From this data, it is shown that μQf product of developing ferrite is up to several decade times as large as conventional ones, and finally, RF power loss is strongly reduced. In fig.4, μQf product is largest around 8 MHz, but the ferrite material for a lower frequency is being developed.

An equivalent lumped circuit of an accelerating cavity is approximately equal to a parallel circuit of a self inductance and a capacitance because the RF power loss of the new ferrite is much smaller and terminating resistor exists in this circuit. It is also a merit that the accelerating cavity can be used for large amplitude. Thus Q-loss effect caused by the excitation of the exchange spin wave associated with the bias field is much less, because the ferrite without bias field is always used in the initial state.

An inner diameter of a ferrite ring cannot be very small because of the bias windings in a conventional cavity[1]. However the inner diameter of the ferrite is a little larger than the outer diameter of the flange of the vacuum duct in a new cavity, because the bias windings are not necessary. Thus the occupation of the ferrite is higher, and the self-inductance turns to be larger. From this point, a length of an accelerating cavity can be shortened. And a high characteristic impedance cavity is realized, if a capacitance of an accelerating gap can be made small.

4. Design and estimation of performance for accelerating cavity

Assuming a diameter of a beam duct is 200mm, its conflat flange cannot be smaller than ICF253. Thus ferrite toroidal core with inner diameter 255 mm is used, and the space between the vacuum duct and the flange is used for the installation space of the baking heater and for insulation. The outer diameter of the commercially available ferrite is 500 mm and its thickness is 25 mm. Since RF power loss of the new ferrite is small, a cooling system for the ferrite RF power loss becomes simpler. The structure of the system is that 1 mm thickness copper plates, whose edges are silver brazed with the copper cooling pipes, are inserted between the 25 mm thickness ferrite alternately.

The relative permeability of the ferrite is determined to be 200 because it is necessary for the ferrite that its permeability is not much changed in a available frequency range below Snoek's limit. Using 20 ferrite cores, the self-inductance is 13.5 μH , and the resonance frequency is 3 MHz, if a capacitance of an

accelerating gap is 200 pF. And the terminating resistor is 200 Ω, because a characteristic impedance is 250 Ω. From the rough estimation as above, 630 V of an accelerating voltage is achieved, in case a 60 cm accelerating cavity is energized by a 1 kW RF power amplifier.

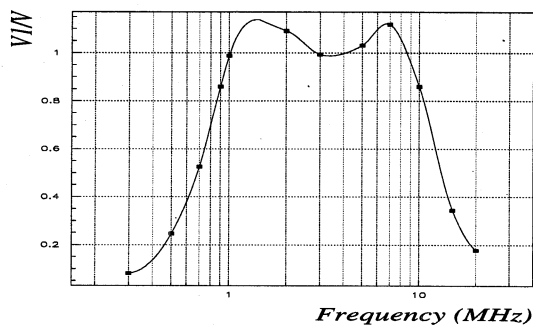

Figure 5: Frequency dependence of $|V_1/V|$ including RF power loss of ferrite.

Fig.5. shows an analysis result for the output voltage of the cavity including the ferrite RF power loss and the frequency dependence of the ferrite complex permeability. From fig.5, the available frequency range, where V_1 exceeds V , does not change so much.

5. Measurement of the performance in an equivalent lumped circuit

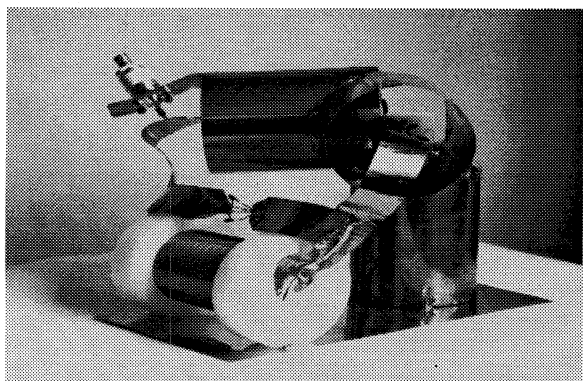

Figure 6: An equivalent lumped circuit model.

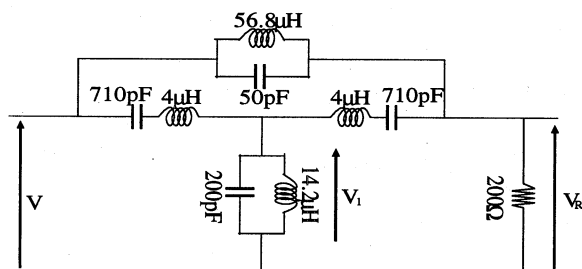

Figure 7: The equivalent lumped circuit model.

The authors fabricated a simple model of an equivalent lumped circuit, regarding an accelerating cavity

as a parallel resonant circuit, and measured the performance. The model is shown in fig.6, and the figure of its equivalent lumped circuit is shown in fig.7. The size of the model is 25 cm × 20 cm × 25 cm. The main body is made of a copper plate, capacitances are ceramic condensers, the inductor of 56.8 μH in fig.7 is ferrite loaded coil, and other inductors are plastic loaded coil. The voltage V_1 in fig.7 is shown in fig.8. It is obvious that the same characteristics as fig.3 and fig.5 appears in fig.8.

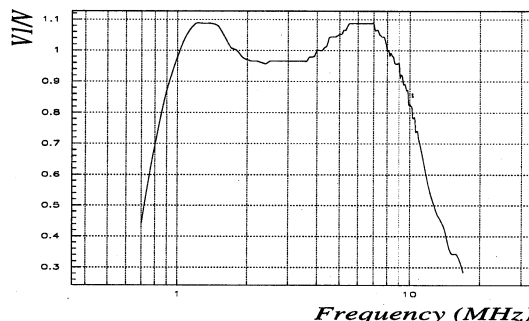

Figure 8: Frequency dependence of the output voltage $|V_1/V|$ of the model.

6. Discussion

In the next stage, the authors will construct a real cavity with a bridged-T type circuit, and will investigate whether the all-pass characteristics are achieved. With developing the ferrite, design of a real cavity is proceeding.

Since the frequency range can be tuned arbitrarily from eq.(4), this cavity can be applied in various synchrotrons. Furthermore, this cavity is also applicable to a rapid cycle synchrotron due to no bias windings.

For a high energy synchrotron, a larger amplitude circuit must be developed.

If an accelerating frequency range is higher than a resonance frequency of a cavity, the influence of the beam loading is avoided. However the case that an accelerating frequency range includes a resonance frequency is under investigation now. And in the bridged-T type circuit, when the cavity is excited by the beam energy, the current taken by the beam is considered to have a band-pass characteristic as the input current. It also must be investigated in the next step.

Acknowledgements

The authors wish to thank Mr. S.Watabe and K.Takamura of TDK for their developing new ferrite.

Reference

[1] M.Kanazawa et al., "RF High Power System of the HIMAC Synchrotron", Proc. of 8th Symp. on Accelerator Science and Technology(1991),p. 161.