

LATTICE COMPONENTS FOR UPGRADING UVSOR

J. Yamazaki, M. Katoh[†], Y. Hori^{*}, M. Hosaka, A. Mochihashi, T. Kinoshita, K. Hayashi, Y. Takashima, Institute for Molecular Science, Myodaiji, Okazaki, Japan
S. Koda, Saga University, Honjo-machi, Saga, Japan

Abstract

In the upgrade plan proposed for UVSOR, the original magnetic lattice will be modified to reduce the emittance and to increase the number of straight sections for insertion devices. We have completed the lattice design. We are designing and developing the lattice components, such as quadrupole/sextupole magnets and the vacuum chambers. Because of the space limitation, sextupoles will be integrated in quadrupoles. We have constructed a prototype of the combined-function magnets. Field measurements are in progress. It has been shown that the magnet is capable of producing required field strengths.

1 INTRODUCTION

UVSOR, a 750 MeV synchrotron light source, has been successfully operational since 1983. During these 18 years, many efforts have been made to keep the performance and reliability of the machine as high as possible. The aged accelerator components have been replaced one by one, year by year. As a result, for example, there were only a few minor troubles during FY2000. However, as for the basic properties of the machine, such as the beam emittance or the number of insertion devices, UVSOR cannot stand comparison with the 3rd generation light sources.

Recently, some of the 2nd generation light sources was or are planned to be reconstructed towards high brilliance [1, 2]. As stimulated by these works, we also have designed a new lattice, which will give a smaller emittance by a factor of 6 and more straight-sections for insertion devices [3]. We have proposed an upgrade plan based on this new lattice and are waiting for the budget.

In this paper, we will describe the magnetic lattice and some results from the recent R&D's on the lattice components.

2 MAGNETIC LATTICE

We are going to modify the magnetic lattice of UVSOR, as shown in Figure 1. The optical functions are shown in Figure 2. The original lattice consists of four DBA cells. There is a triplet between two bending magnets. Dispersion function has non-zero value between the two bending magnets and becomes zero in the straight-

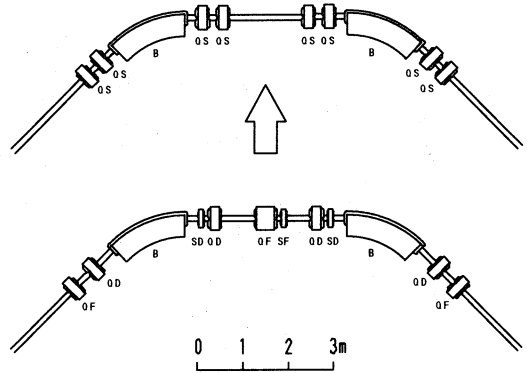

Fig. 1. Lattice modification. The lower is the present configuration and the upper is the upgraded one. One quadrant of the ring is shown.

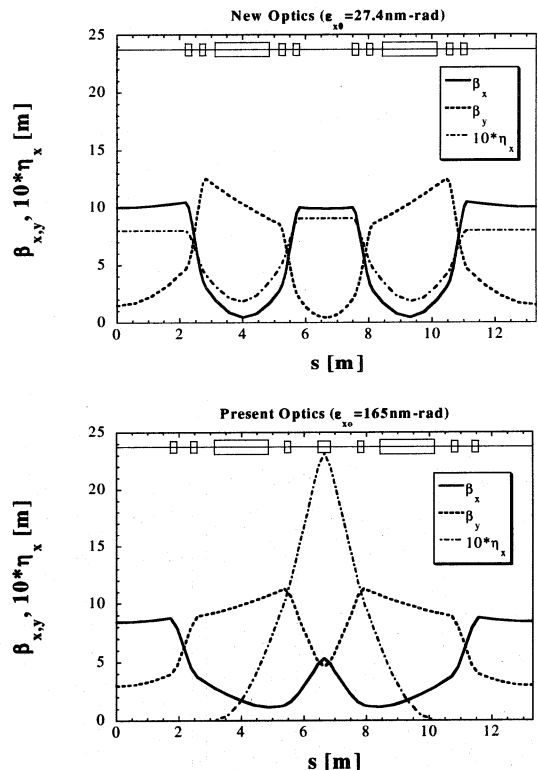

Fig.2. Optical functions of present (lower) and upgraded (upper) lattice (one quadrant of the ring is shown)

[†]mkatoh@ims.ac.jp

^{*} a guest scientist from KEK-PF

sections. In the new lattice, the triplet is replaced with two doublets and there is one short straight section between them. The dispersion function is not eliminated in the straight sections. This is effective to reduce the emittance. The vertical betatron function at each straight section is small and optimised for installing narrow-gap insertion devices, such as in-vacuum short period undulators.

To make the newly created straight sections as long as possible, all the quadrupoles and sextupoles will be replaced with combined function magnets, which are capable of producing both quadrupole and sextupole fields. The details of the magnets are described in the next section.

Table 1. Main Parameters of UVSOR

	Present	Upgraded
Circumference	53.2 m	
Lattice Type	DBA	extended DB(A)
Number of Cells	4	4
Straight Sections	3m x 4	4m x 4, 1.5m x 4
Beam Energy	750 MeV	
Emittance	165 nm-rad	27.4 nm-rad
Energy Spread	4.2×10^{-4}	
Betatron Tunes	(3.16, 1.44)	(3.75, 3.20)
Nat. Chromaticity	(-3.4, -2.5)	(-8.1, -7.3)
XY Coupling	~10%	
Mom. Comp. Factor	0.026	0.028

3 MAGNET

In the new lattice, the space limitation is very severe. In some of the modern light sources, sextupoles are integrated in the quadrupole magnets, to save the space and reduce the cost [4, 5]. They are successfully operational. We decided to introduce this type of magnet. There are several types of configuration. We have adopted the configuration as shown in Figure 3. The shape of the iron core is same as ordinary quadrupoles. The auxiliary coils on the pole face (sextupole coils) produce dipole field and sextupole field. Other auxiliary coils on the poles (dipole correction coils) eliminate the dipole field. The main parameters of the magnet are summarized in Table 2.

A prototype was constructed as shown in Figure 4. Field measurements are in progress. Some results from the field measurements are shown in Figure 5 and 6. It was proved that the quadrupole and sextupole field required from the lattice could be achieved well below the maximum excitation current. It was also proved that the dipole field could be eliminated by exciting the dipole correction coils, for the typical operational currents of quadrupole and sextupole. However, at around the maximum excitation of quadrupole and sextupole where the iron core is saturated, it was found that the dipole field could not be eliminated even with the maximum excitation of the dipole correction coils.

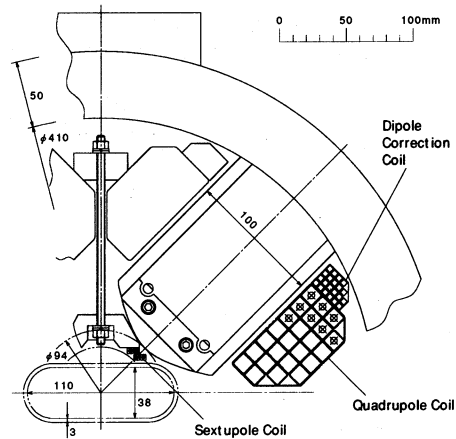

Fig.3 Combined-function (quadrupole/sextupole) magnet (cross-sectional view)

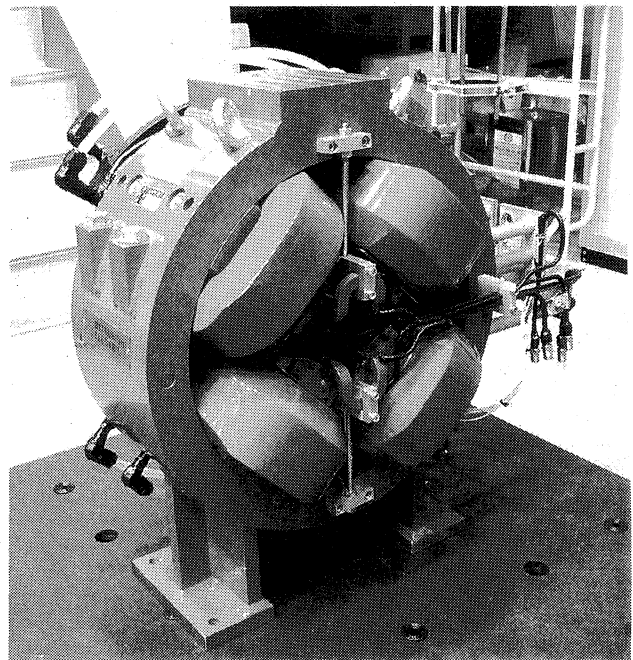

Fig.4 Prototype of the combined function magnet (Constructed by Mitsubishi Electric Co.)

Table 2. Parameters of focusing magnets

Core Length	0.2 m
Bore Diameter	94 mm
Quadrupole Coil	625A x 24 turns
Sextupole Coil	400A x 4 turns
Dipole Correction Coil	40A x 21 turns
Maximum Quadrupole Field	15 T/m
Maximum Sextupole Field	35 T/m ²

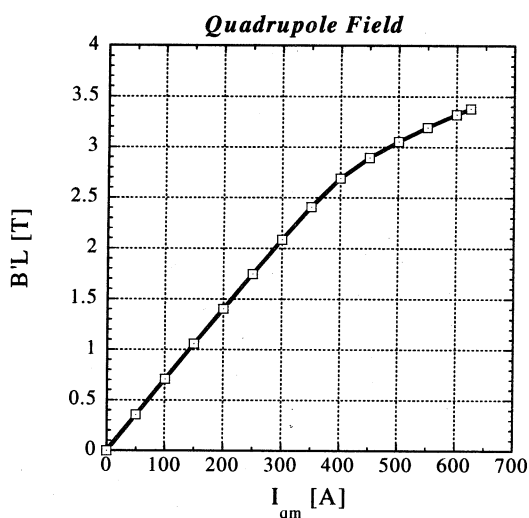

Fig.5 Excitation curve of quadrupole field
Typical operational current will be around 400A.

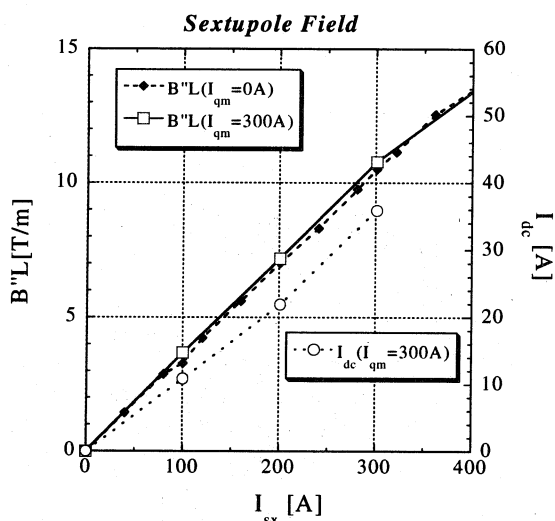

Fig.6 Excitation curve of sextupole field
Typical operational current will be around 200A.
The dipole correction current is shown for the quadrupole excitation at 300A.

4 VACUUM SYSTEM

The design work on the vacuum system is in progress. As an example, the layout of the vacuum components at a short straight section is shown in Figure 6. The cross section of the beam pipe is basically kept same as that of the present ones, which is a racetrack shape. In the tentative design, because of the space limitation, the chambers are pumped by NEG pumps, which are mounted on the side room of the pipe as shown in Figure 7. There is installed a water channel on the other side, preparing for future high current operation. Sputter ion pumps and NEG pumps are installed on the undulator chamber.

At present, pickup electrodes for beam position monitors (BPM) are mounted only on the bending magnet chambers. Since these chambers are not mechanically fixed to the magnets, the BPMs can be moved relative to the magnets. To prevent this, we are going to install a BPM on each beam pipe at the quadrupole doublets. They will be mechanically fixed to the magnets.

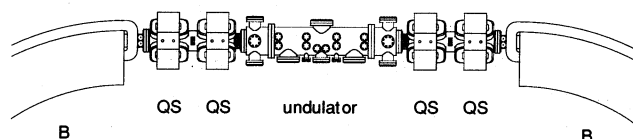

Figure 6 Layout of the vacuum components at a short straight section

A chamber for in-vacuum undulator is also shown.

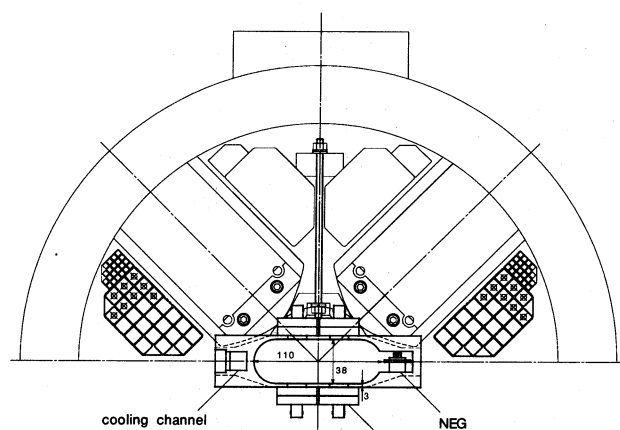

Fig. 6 Tentative design of the vacuum chamber
(Cross-sectional view)

5 SUMMARY

UVSOR is a relatively small synchrotron light source, which was built early in 1980's. Although this is a typical 2nd generation light source, a moderately small change of the magnetic lattice will convert this old machine to a high brilliance light source that can compete with the 3rd generation light sources in the next decade. Combined-function (quadrupole/sextupole) magnet was designed. A prototype was constructed. The field measurement proved that the required magnetic field could be achieved. The design study on the vacuum system is in progress.

6 REFERENCES

- [1] M. Katoh et al., J. Synchrotron Rad. 5 (1998), 336
- [2] S. Brennan and R. Hettel, Synchrotron Radiation News, Vol.11, No. 1 (1998), 25
- [3] M. Katoh et al., Nucl. Inst. Meth. A467-8 (2001), 68
- [4] M. Barthes et al., Proc. 9th International Conference on Magnet Technology (Zurich, 1985), p.114
- [5] M. Eriksson, Proc. Of 5th European Particle Acc. Conf. (Sitges, 1996), 72