

DEVELOPMENT AND INSTALLATION OF A SINGLE-PASS BEAM POSITION MONITOR IN KEKB

H. Ishii, Y. Onishi, M. Tobiyaama, K. Mori, M. Tejima and S. Hiramatsu

KEK, Tsukuba, Japan

Abstract

A single-pass beam position monitor (SPBPM) was developed for measuring of the injection beam orbit of the KEK B-factory (KEKB), and 21 sets have already been installed. We adopted log-ratio processing using a logarithmic (log) amplifier for the SPBPM of KEKB. The measurement circuit consists of four log-amplifiers, four peak-hold circuits, four analog-digital converters (ADC), a memory circuit and a timing control circuit. Moreover, it coexists with the existing beam position monitor (BPM) system for a closed-orbit distortion (COD) measurement. In order to choose the BPM signal of the low energy ring (LER) and the high energy ring (HER) of KEKB, an RF signal switch circuit was also manufactured. These circuits were controlled by the same VXI standard as the existing BPM system. This report summarizes the SPBPM system and its performance.

INTRODUCTION

The KEKB accelerator is a collider comprising a positron ring (LER) of 3.5 GeV and an electron ring (HER) of 8 GeV. This May, the KEKB accelerator achieved the design value of the peak luminosity of above $10^{34} \text{ cm}^{-2}\text{sec}^{-1}$. For high-luminosity operation, a precise control of the beam orbit in an accelerator based on the BPM system is required. The existing BPM system [1] is a high-precision measurement BPM system with an accuracy of a few micron-meters or less, and has been used to measure the COD since the start of commissioning in December, 1998. HER and LER are equipped with 443 and 454 BPM pickups, respectively. The beam signals from the four button electrodes of each BPM pickup are transmitted through independent coaxial cables with lengths of 40–240 m. In order to realize a high measurement accuracy to the present system, the detection circuit method of the so-called narrow band was adopted. The signal component at the 2nd harmonic frequency (1018 MHz) of the accelerating RF frequency (509 MHz) is detected using super-heterodyne circuits and a spectrum analysis by means of a fast Fourier transform (FFT). Although the existing BPM system is advantageous for processing a signal, like an accumulation beam at hardly changed in time, there is a disadvantage, which cannot respond to an oscillation of a several 10 kHz beam signal, like in the case of beam injection. In order to compensate for such a fault, a SPBPM system has been installed in KEKB.

PERFORMANCE SPECIFICATION

There are two purposes for the installing of the SPBPM in KEKB. One is to search for the optimum parameter to inject a beam to each ring from the linac. The 2nd is to measure the betatron phase advance of each ring for optics diagnosis. Since the electric charge per beam bunch is very small in the case of beam injection, the SPBPM must detect very weak signals, especially the positron beam for LER, it is about 0.3 nano-coulomb (nC). Thus, the required resolution is less than 0.5 mm.

Moreover, in the case of optics diagnosis of each ring, the SPBPM must measure the beam position with a high resolution of less than 0.1 mm while accumulating a single-bunch beam charge of 10 nC. Such required conditions are summarized as shown in Table 1.

Table 1: Specifications for the SPBPM

Beam current	Expected signal power (250MHz)	Required resolution
10 nC(6.25*10 ¹⁰ PPP)	-30 dBm	0.1 mm
0.3 nC(1.88*10 ⁹ PPP)	-60 dBm	0.5 mm

SIGNAL PROCESING CIRCUIT

To satisfy the above requirements, a signal detector must cover a wide dynamic range (50 dB). In order to realize wide-range detection, we decided to adopt a log-amplifier circuit. Such a signal processing method is called the log-ratio BPM [2].

The electronics for the SPBPM consists of four log-amplifiers, four peak-hold circuits, four ADCs, a memory circuit and a timing control circuit, as shown in Figure 1. Firstly, each signal voltage of four electrodes from a BPM pickup is inputted into a linear amplifier through a band pass filter (a center frequency of 250 MHz with a band width of 12.5 MHz). The output signal of a linear amplifier is inputted into a log-amplifier, and the peak voltage is sampled and held.

Synchronizing with a beam signal, four peak voltages are converted to a 12-bit digital value to be recorded in memory, respectively, by the clock of a timing control circuit. The SPBPM circuit can store digital data of each electrode of turn by turn for a maximum of 16384 times. The timing control circuit has a function to synchronize the signal for every BPM and the time of conversion for the ADC by lag time adjustment.

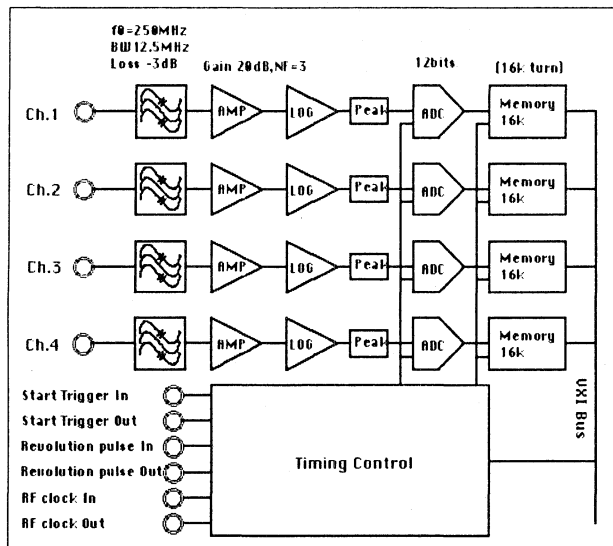

Figure 1: Block diagram for SPBPM

Since the SPBPM system coexists with the existing BPM system, we have manufactured a relay module to change the signal of the BPM button electrode between the SPBPM and the existing BPM. The function can also change the signals of HER and LER, that is, the SPBPM measures the beam position of both rings, HER and LER in a common circuit. The SPBPM system is controlled by a VXI-bus (VME-bus Extension for Instrumentation) standard, like the existing system.

BENCH TESTING

A sinusoidal wave of 250 MHz from signal-generating equipment was inputted into a single-turn BPM circuit, and the performance was examined by a bench test. As shown in Figure 2, the line of the output voltage of a log-amplifier is linear to an incoming signal of -70 ~ -10 dBm, but the signal level is less than -70 dBm, this has been shown for the characteristic of a log-amplifier that linearity becomes a worse rapidly. The SPBPM has a position resolution of 0.3 mm at the point of -60 dBm input, which corresponds to a beam charge of ~ 0.3 nC injected from the linac, and 0.1 mm in the region of -40 ~ -10 dBm.

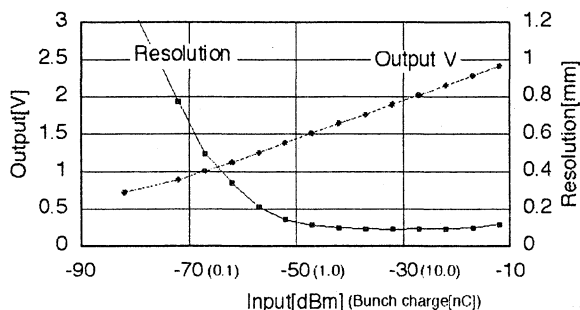

Figure 2: Output voltage and resolution for the SPBPM to the input signal power

BEAM POSITION FORMULA

The beam position of the log ratio-BPM of KEKB is able to be calculated using the following formulas:

$$X = C_x \times \{ \text{Log}(V_A/V_C) - \text{Log}(V_B/V_D) \},$$

$$Y = C_y \times \{ \text{Log}(V_A/V_C) + \text{Log}(V_B/V_D) \}.$$

The four-signal voltage of each electrode is set to V_A , V_B , V_C , and V_D . C_x and C_y are the position conversion coefficients.

In order to estimate the position conversion coefficient of the log-ratio BPM, the mapping data for the log-ratio BPMs were calculated by log conversion of the usual mapping data, as shown in Figure 3.

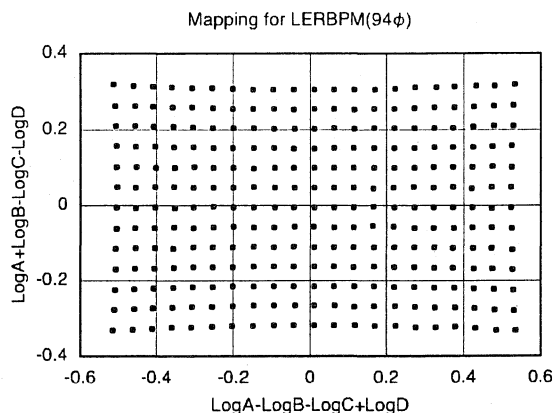

Figure 3: Mapping for the SPBPM

Figure 4 shows the Log ratio to the beam position on an axis of coordinates of the LER BPM and HER BPM. Both figures show that not only a circular LER beam chamber, but a racetrack HER chamber, has very good linearity. The inclination of this straight line is equivalent to a beam position conversion coefficient. Their typical coefficients for HER and LER are estimated from these lines as follows:

LER arc section C_x and $C_y = 38.0$ [mm/V]

HER arc section $C_x = 22.18$ [mm/V], $C_y = 31.78$ [mm/V]

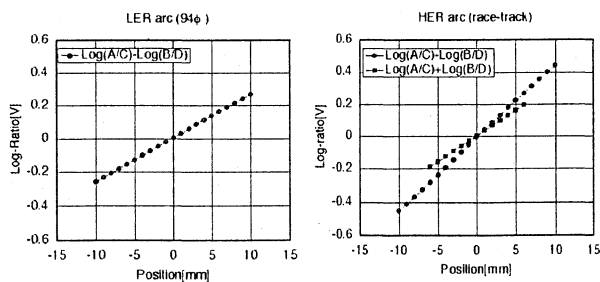

Figure 4: Log ratio value to the beam position on an axis of coordinates of LER BPM and HER BPM.

ACTUAL BEAM POSITION MEASUREMENT

21 SPBPMs were installed in KEKB by this June. In order to check the performance of these SPBPMs, we measured the beam position using an actual beam.

Measurement of the injection beam

An orbital measurement of first injection of the positron beam to the LER is shown in Figure 5. The vibration of the beam based on the injection error was observed using a beam signal of 0.5 nC (-56 dBm). Since the betatron tune is close to a half integer, the beam position is changing to the opposite direction during every turn. At the first turn after beam injection, an electric charge of about 0.5 nC was injected in LER, which decreased to about 0.2 nC after ten or more turns.

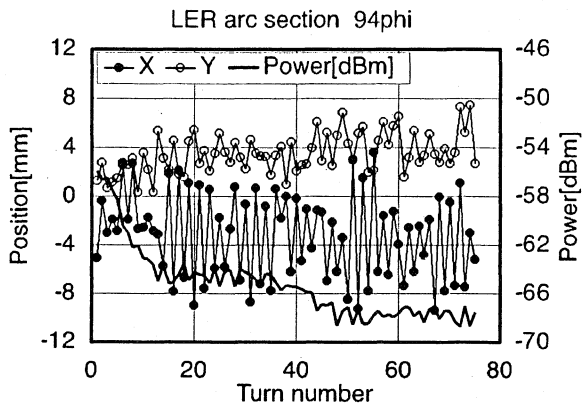

Figure 5: Orbital measurement of first injection of the positron beam to LER.

Measurement of a single bunch beam in the accumulation mode

Next, a single bunch beam (1 mA) was examined in the accumulation mode by SPBPM. Since the beam was kicked by a horizontal kicker magnet, the horizontal damped oscillation was observed as shown in Figure 6.

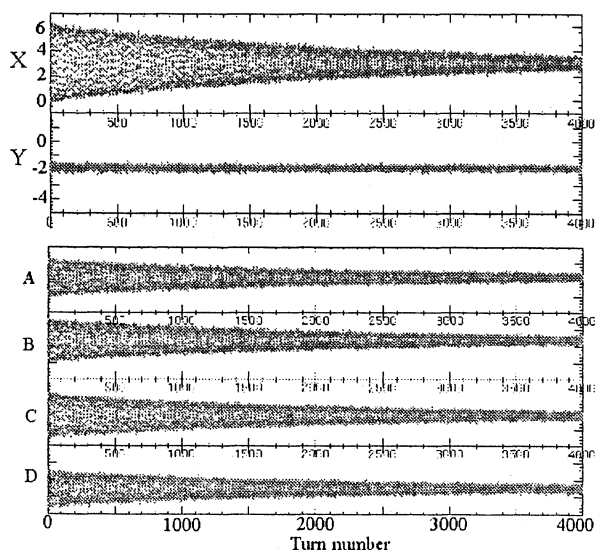

Figure 6: Beam position of turn by turn. Upper, Horizontal beam position; Middle, Vertical beam position; Lower, Four outputs of SPBPM.

The system resolution for a beam position measurement was estimated from the standard deviation of the beam position of 4096 turns. It was confirmed that the resolution of the LER arc section and the HER arc section was about 0.1 mm for a beam of 1mA (10 nC) as a requirement.

Comparison of SPBPM and existing BPM

Last, the consistency of the position sensitivity between the existing BPM and the SPBPM was measured by single kick orbit of a beam. Since only 21 sets are still installed, an SPBPM measurement has few measuring points compared with the existing BPM measurement system, as shown in Figure 7. The measured values of existing BPM and SPBPM mostly corresponded.

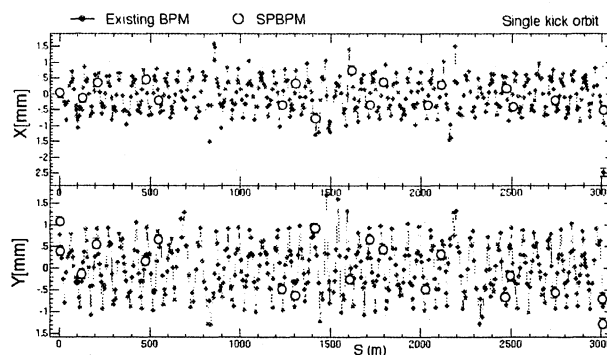

Figure 7: The consistency of the position sensitivity between the existing BPM and the SPBPM.

CONCLUSION

For beam injection tuning and optics diagnosis, a single-pass BPM system based on log-ratio BPM was developed. We investigated the performance of this single-pass BPM using an actual beam. That is, the beam position of a low electric charge bunch of 0.3 nC could be measured, and the single pass BPM could measure an incoming beam signal of -30 dBm with about 0.1 mm resolution. At KEKB, it is scheduled to extend eight more sets next year and to extend in the future to 120 sets.

ACKNOWLEDGMENTS

The author appreciates the support of this work by Sony-Tektronix Ltd and Artek Inc.

REFERENCES

- [1] M. Tejima, et al., "BEAM POSITION MONITOR SYSTEM FOR KEKB", Proc. EPAC2000
- [2] Robert E. Shafer, "Log-Ratio Signal-Processing Technique for Beam Position Monitors", Proc. Fourth Accelerator Inseminations Workshop, Barkeley 1992.